

4TH COPY

ELECTRICAL COMMUNICATION

APRIL

No. 4

1934

VOL. 12

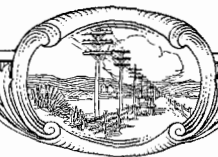

ELECTRICAL COMMUNICATION

A Journal of Progress in the
Telephone, Telegraph and Radio Art

H. T. KOHLHAAS, Editor

EDITORIAL BOARD

E. A. Brofos P. K. Condict G. Deakin E. M. Deloraine P. E. Erikson John W. Foard
James E. Fullam F. Gill Frank C. Page H. M. Pease G. E. Pingree

Published Quarterly by the

International Standard Electric Corporation

Head Offices

67 BROAD STREET, NEW YORK, N. Y., U. S. A.

European General Offices

CONNAUGHT HOUSE, ALDWYCH, LONDON, W. C. 2, ENGLAND

G. E. Pingree, President

S. G. Ordway, Secretary

Joseph A. Redegeld, Treasurer

Subscription, \$3.00 per year; single copies 75 cents

Volume XII

APRIL, 1934

Number 4.

CONTENTS

| | PAGE |
|---|------|
| BRITISH EMPIRE BROADCASTING..... | 235 |
| <i>By C. M. Benham, B.Sc., A.C.G.I. and P. H. Spagnoletti, M.A.</i> | |
| ASPECTS OF MODERN CENTRAL OFFICE INSTALLATION PRACTICE—BYPATH SYSTEM..... | 247 |
| <i>By L. Palmer</i> | |
| FUNDAMENTAL PLAN, 1931-1950—BUENOS AIRES AND SUB-URBS..... | 257 |
| <i>By Ricardo T. Mulleady, B.Sc. and C. G. Barker, A.C.G.I., M.I.E.E.</i> | |
| THE PRACTICAL APPLICATION OF THE NEW UNIT OF CIRCUIT PERFORMANCE..... | 270 |
| <i>By J. Collard, Ph.D.</i> | |
| APPLICATION OF TYPE C AND TYPE D CARRIER SYSTEMS TO NON-STANDARD LINES..... | 276 |
| <i>By Bruce H. McCurdy and J. H. Holmes</i> | |
| NEW FINAL SELECTOR FACILITIES FOR STEP-BY-STEP SYSTEMS..... | 286 |
| <i>By E. P. G. Wright, A.M.I.E.E.</i> | |
| THE BUDAPEST ANTI-FADING ANTENNA..... | 289 |
| <i>By F. Holland, C. E. Strong and F. C. McLean</i> | |
| "STANDARD" HIGH POWER BROADCASTING TRANSMITTERS AT BUDAPEST AND KALUNDBORG..... | 299 |
| <i>By C. E. Strong</i> | |
| AUTOMATIC LONG DISTANCE SWITCHING AND NATIONAL DIALING—BASLE, SWITZERLAND..... | 311 |
| <i>By E. Frey, Basle</i> | |



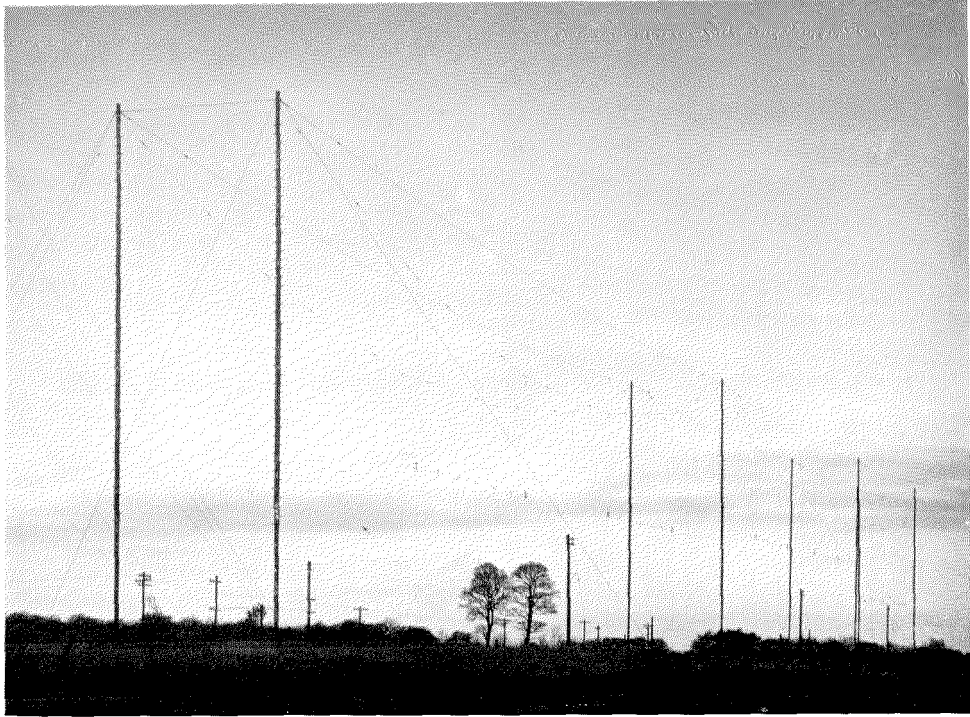

THE
INDIAN ZONE BLOCK
OF
AERIAL ARRAYS
EMPIRE BROADCASTING

British Empire Broadcasting

By C. M. BENHAM, B.Sc., A.C.G.I., and P. H. SPAGNOLETTI, M.A.

Standard Telephones and Cables, Limited

THE provision of a broadcast service from the home country to the distant regions of the Empire has for some years past confronted the British Broadcasting Corporation with a problem of ever increasing urgency and great technical complexity. Now this undertaking, surely one of the most ambitious yet attempted in broadcasting, has at last been successfully brought into practical operation.

Progress is never steady but is marked with periods of obvious achievement and periods of apparent stagnation. It is, however, in these periods during which no creative work is evident, that the way to future attainments is paved. Over eight years ago the long distance radio telephone service opened a new era in world communication. Since then, expansion of this service

has taken place, until now practically every country in the world is in telephonic communication with every other. The period occupied by this expansion may have appeared to many as one of technical stagnation, but in reality, by allowing the accumulation of data relating to short-wave propagation, it has made possible the new Empire service.

It is no exaggeration to say that the entire engineering of the Empire Broadcasting Station has revolved round the question of wavelengths.

Long distance radio communication is practical, except in special cases, only when short wavelengths are used, and the Empire equipment must, therefore, be of the short-wave type. Fortunately, the colonies and dominions of

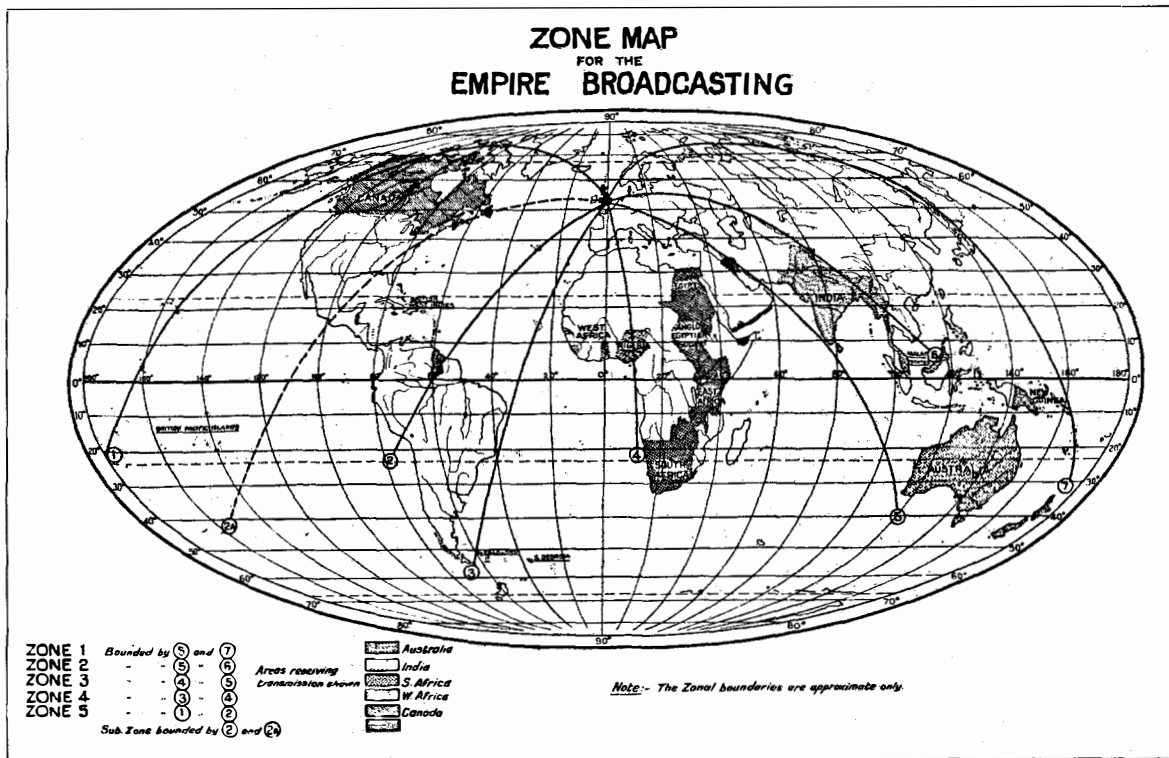

Figure 1—Zone Map.

the British Empire are so distributed longitudinally as to be conveniently divided into time zones, i.e., areas which have approximately the same local time. This will lead naturally to four main zones:

| Zone | Time Displacement from London |
|----------------|----------------------------------|
| Australia..... | 8 hours early |
| India..... | 4 hours early |
| Africa..... | 0 |
| Canada..... | 6 hours late |

The result of such a division is that each zone may be treated separately and the best conditions obtained for the individual areas; Empire broadcasting thus becoming a question of transmission to areas as opposed to non-directive transmission or general broadcasting. This zonal division has the advantage that radiation may be concentrated over the desired area, giving a gain in field strength received. Furthermore, different wavelengths may be used for the various zones. This last point is of great importance and dominates the whole scheme (Fig. 1).

Considering the first of the four zones given above—Australia—this is the farthest away of all, and transmission must travel through twilight conditions whichever path around the world is used. It will not be expected, therefore, that wavelengths of 15 metres, using the daylight path, or 37 metres using the dark path, will give reliable service; both may be used for short periods, but their useful duration is limited and uncertain. The twilight band (25-29 metres) has been found to give the most reliable service, using either the dark or daylight path as conditions demand.

The second zone—India—presents a different problem. During the day 17-metre transmissions have been found to be very satisfactory, although the useful period of this wavelength is much curtailed in winter due to the lower ionisation in the upper layers. Towards dusk, and for a period varying with the time of the year, this zone may be served by a wavelength in the neighbourhood of 25 metres, being followed approximately two hours later by the regular night wave of about 32 metres.

In the case of the third zone—Africa—the problem is very similar to the preceding one.

These territories lie almost due south and during the day shorter wavelengths may be used with excellent results. The twilight conditions demanding intermediate wavelengths last for a comparatively brief period before the regular night waves of 32 metres, or even longer, become operative. The British territories in this zone vary enormously in distance from England, and for the nearer areas it will be advisable to utilise a longer wavelength. A further complication in the case of Africa is the question of interference from atmospherics and this has resulted in using shorter wavelengths (25 metres) which, although they give lower field strength at night, have a higher field strength to noise level ratio. If Africa is treated as a whole, the angles subtended by the farthest east and farthest west points will prevent any useful concentration of radiation, and for this reason Africa is best divided into two zones.

The position of the dividing line is based on the fact that the Cape and surrounding area require shorter wavelengths for day transmissions, while the western area, being closer to England, may be more advantageously served on the longer bands.

The last big group of British territories includes Canada. The great circle path to Canada passes very near to the North Pole and even in summer we cannot call this a true daylight path. All wavelengths, therefore, will be higher than normal for distances of this order. Particularly will this be the case for the next two or three years as we have been in a period of minimum sun spot activity. A satisfactory day wave for Canada would be of the order of 19 metres, and night waves of 31, 50 and even as high as 70 or 80 metres may be used. Naturally we should expect that on this circuit, which is entirely confined to the Northern Hemisphere, conditions would be more affected by seasonal variations than would be the case with circuits which are equally in both hemispheres, such as the South African circuit.

Before considering the transmitting apparatus, it is convenient to examine the aerial arrays used in the fulfillment of the zone scheme outlined above. These arrays are divided into five blocks, one for each zone, distributed round the transmitter building (Fig. 2). The site being high,

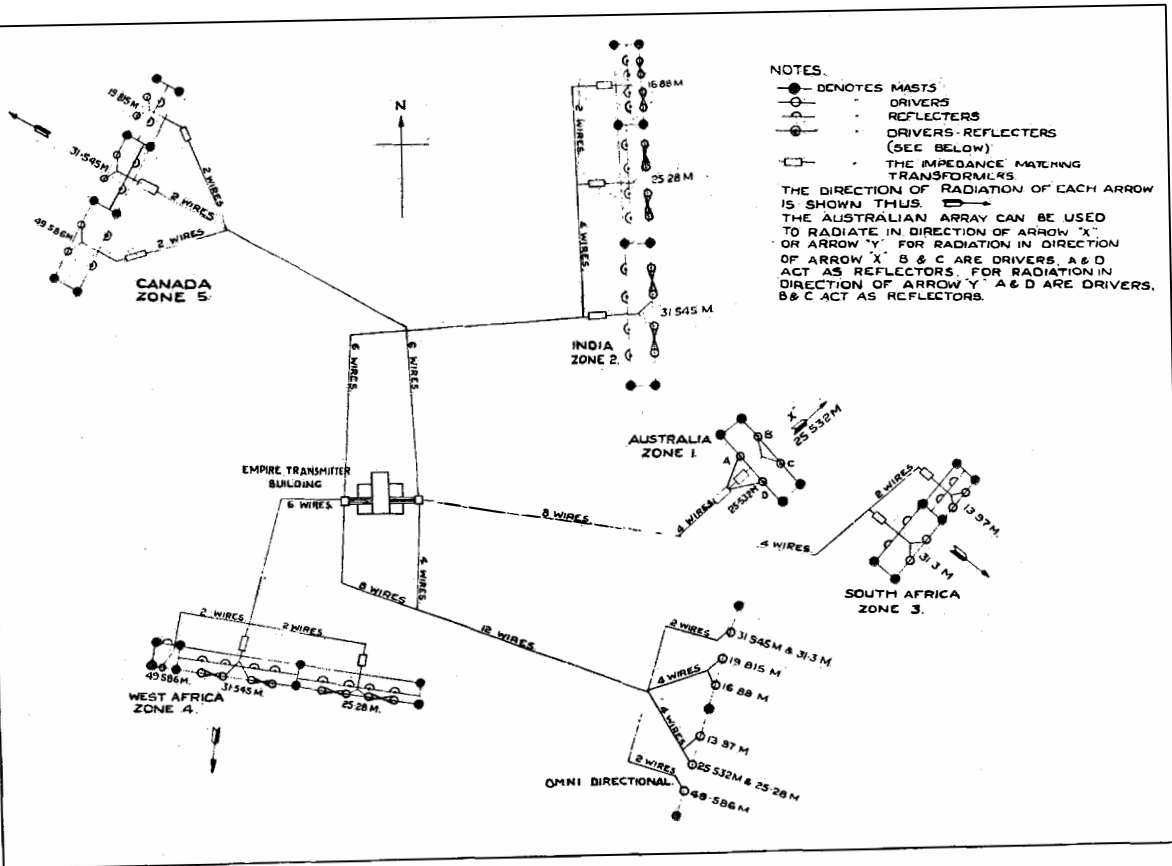

Figure 2—Diagram—Empire Station Aerials and Transmission Lines.

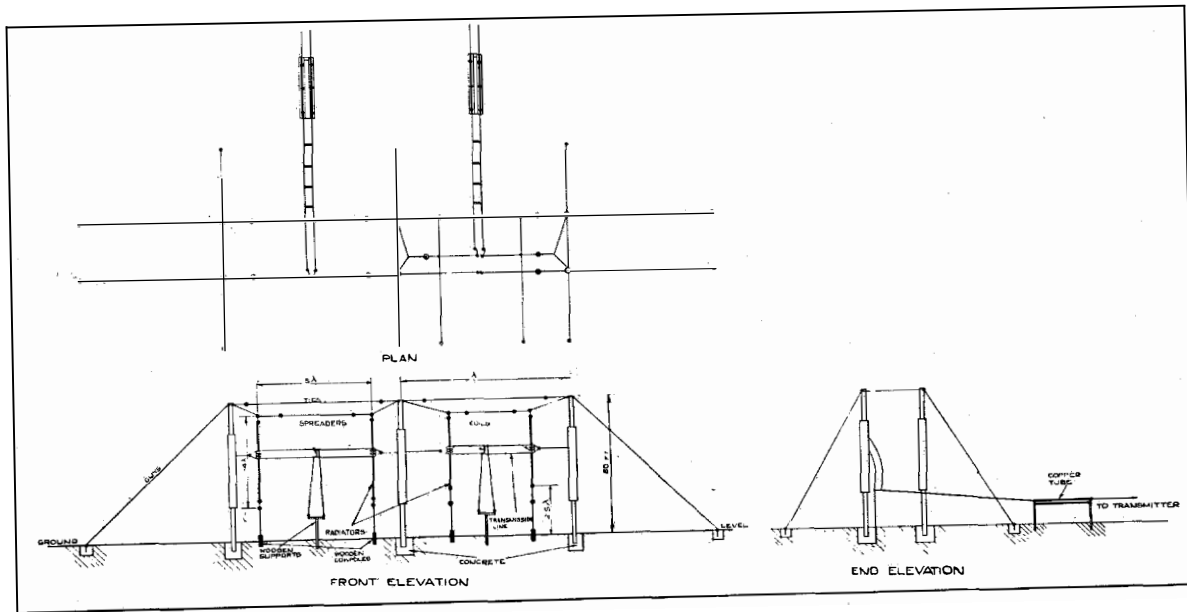

Figure 3—Diagram—Simple Directive Transmitting Antenna for Empire Broadcasters, Showing Two Element Structure.

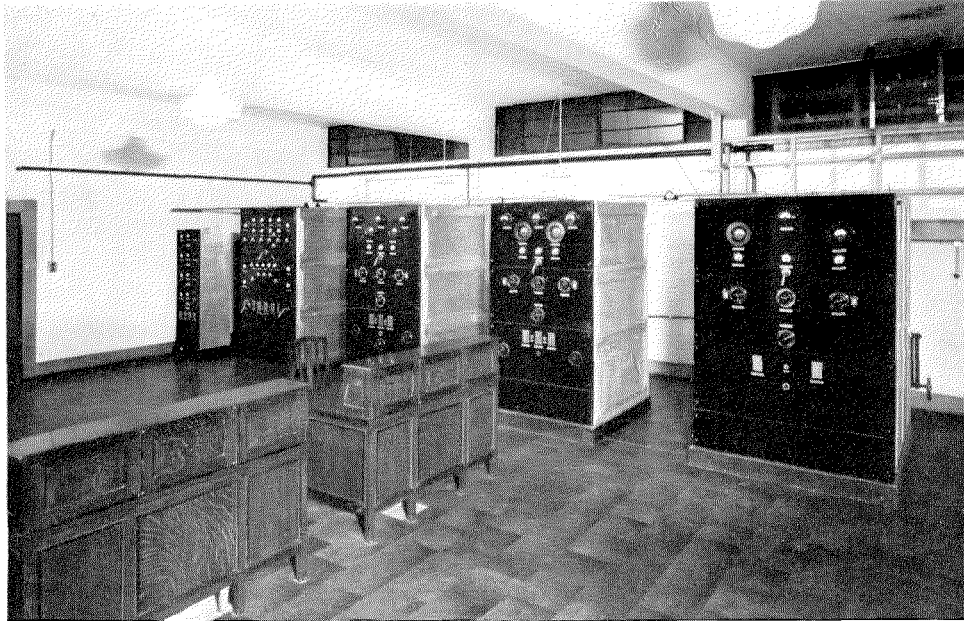

Figure 4—View of One Transmitter Showing the Five Radio Units and the Control Desks in the Foreground.

the ground falling away on all sides, an “unopposed view” is obtained by every array of at least ten miles—considerably reducing ground and obstacle absorption.

The individual blocks are simple both in character and structure. They are best visualised with reference to the simplified drawing reproduced in Fig. 3. Vertical dipoles and reflectors are used, the number of elements depending on the aperture of the beam required. The type of mast employed for supporting these aerial arrays was determined by two factors—economy, since the scheme was to a great extent experimental, and the elimination of unnecessary stay wires. The masts taper at both ends and require to be stayed only at the top. All the essential stays and flying stays, the number of which has been reduced to a minimum, have been broken up by insulators to reduce the possibility of resonance.

We have now outlined the main considerations involved in transmission to the colonies, from which it will be possible to envisage the type of

apparatus required for the transmitters. Due to the desirability of giving programs to the zones on alternative wavelengths (we are not able to select the optimum wavelength for each day as in commercial radio telephony), two transmitters are necessary with facilities for complete interchangeability between these and all the aerial arrays. The transmitters themselves must be capable of working over the band from 13 to approximately 50 metres, and must have arrangements for quick wave changing on any of the broadcast allocations in this band.

Figs. 4 to 10 and the Frontispiece show views of the Empire Broadcasting Station.

Radio Transmitters

The two radio transmitters are housed in a single building containing all the apparatus for generating a high frequency carrier and modulating this with speech or music. The station is operated, as will be shown later, from a ring main and, in view of the reliability of this source of supply, prime movers have not been installed.

Layout

The layout of the short-wave station depends mainly on three factors:

- (1) Electrical considerations.
- (2) Economy in space and material.
- (3) Appearance.

1. *Electrical Considerations.*

It is, of course, necessary to keep the low power ends of both equipments away from the power amplifying stages, and the line amplifying equipment must be isolated as far as possible from the radio circuits. Further, it is desirable to arrange for the control of all apparatus to be located near the radio units themselves; the reason for this is important in this particular case of broadcasting, since the transmitter has to be started up and shut down often during the course of a day's operation. The last stages must be placed so that they can easily be connected to the transmission lines through the aerial selector switch and at the same time give the facility for changing one transmitter to the set of aerials normally associated with the other.

2. *Economy.*

On large installations the cost of cabling and

cable ducts forms a very considerable proportion of the whole. The apparatus must, therefore, be distributed so as to keep the leads short and avoid long and unnecessary trenches.

3. *Appearance.*

Symmetry of layout and suitable placing of apparatus means that the finished station gives a good impression to visitors and to the operating staff, and this in turn reacts favourably on its operation and maintenance.

The layout shown in Fig. 11 was decided upon as the one fulfilling the above requirements to the greatest degree.

The speech input equipment is situated in the two rooms near the entrance of the building. These rooms are screened electrically by copper cloth which is connected to earth immediately outside the building, while the power supply apparatus, installed in a near-by room, feeds the equipment through screened cables. The main transmitting hall houses the twin transmitters; these are situated on either side of the hall facing inwards, with the low power units near the entrance and the high power units at the farther end.



Figure 5—Transmitter Hall Showing Twin Transmitters on Either Side and Power Control Board at End.

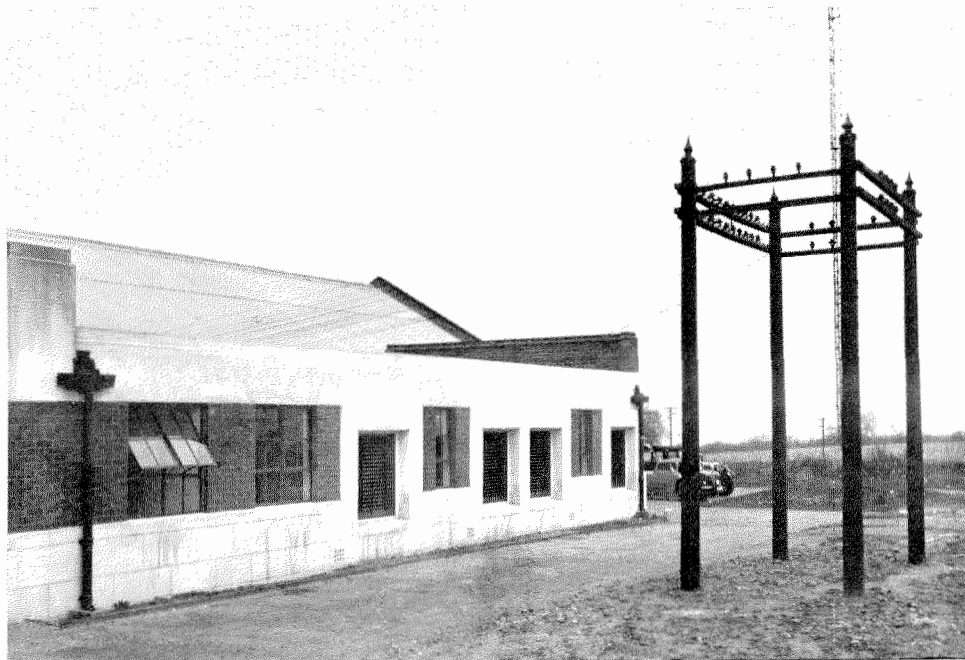

Figure 6—Distribution of Framework for Transmission Lines.

Facing the entrance to the room are the control boards and the high tension rectifying plant supplying the anode voltage for the later stages of amplification. The array selection platform and the transmission lines to this are directly above the last amplifier. There are ten transmission lines (twenty wires) terminated at each of the windows where switching is affected by a simple plug and socket arrangement.

On the left of the main hall is the cooling room containing water pumps and air blowers with their necessary starting apparatus. This room is separated from the main hall by two smaller rooms, one containing the rectifying equipment for the speech input apparatus, and the other being a valve and general store, with the result that there is little mechanical disturbance in the transmitting hall due to the cooling plant.

At the right-hand side of the transmitting hall is the power generator room. All generators are in triplicate, thus providing a spare set which is made easily available for use by the transfer switchgear (situated on the left-hand side of the

room). The substation which houses the incoming supply transformer and the main induction regulator forms a separate room in this right-hand wing of the building.

The whole layout is remarkably compact, at the same time of good accessibility and appearance.

Description of the System and Apparatus in the Transmitting Building (Fig. 12)

The line amplifying equipment is simple in function and design. The program from the main studios is carried by land to the radio station where it is amplified by these line amplifiers to a suitable level for the input of the transmitters. The amplifier consists of two resistance-capacity-coupled stages, the input and output impedances being 600 ohms. Its frequency characteristics are almost flat from 30 to 10,000 cycles, the maximum variation being $\frac{1}{2}$ db. over this range.

A program volume indicator is provided with a decibel characteristic enabling a good visual check to be obtained on the acoustic level.

The control rooms are acoustically treated in order that they may act as quality checking rooms. A key on the input to the monitoring amplifier enables it to be switched either to the output of the line amplifier or to the output of a small rectifier fed from the last stage of radio frequency amplification. A direct comparison may, therefore, be made between the program provided to the transmitter, and the program after rectification from the last stage of the transmitter itself.

Power supplies for this equipment are obtained from rectifiers. Two low tension rectifiers, one normally acting as a spare, and two high tension rectifiers are assembled on two racks. Dry plate rectifiers are used for the low tension, while hot cathode mercury vapour valves are the rectifiers used on the high tension side. A further rack of apparatus contains the necessary smoothing equipment for the filaments, grid bias and high tension. (The grid bias is also obtained from a rectifier fitted to the smoothing rack.) It is interesting to note that not a single battery of any kind is used in the entire installation.

Transmitter.

The transmitting apparatus itself is housed in five units. Each transmitter is tuned to operate on any of six wavelengths between 16.9 and 50 metres. These six bands are specially reserved for short-wave broadcasting. The transmitter is capable of giving unmodulated carrier power of 12 kW and this can be modulated to 95% without any appreciable distortion; that is, the strength of the audio frequency harmonics introduced into the modulation envelope is 30 decibels below the fundamental modulating tone.

The functions of the five units are as follows:

The first unit of each transmitter contains four crystal oscillators. Any one of these can be switched on to the transmitter with which it normally works or, if desired, on to the other transmitter. Each transmitter, therefore, may operate on one of eight frequencies. The frequency stability of these oscillators is approximately forty parts to one million, care having been taken to eliminate variations due to temperature or voltage on this stage. The second unit contains circuits for raising the crystal

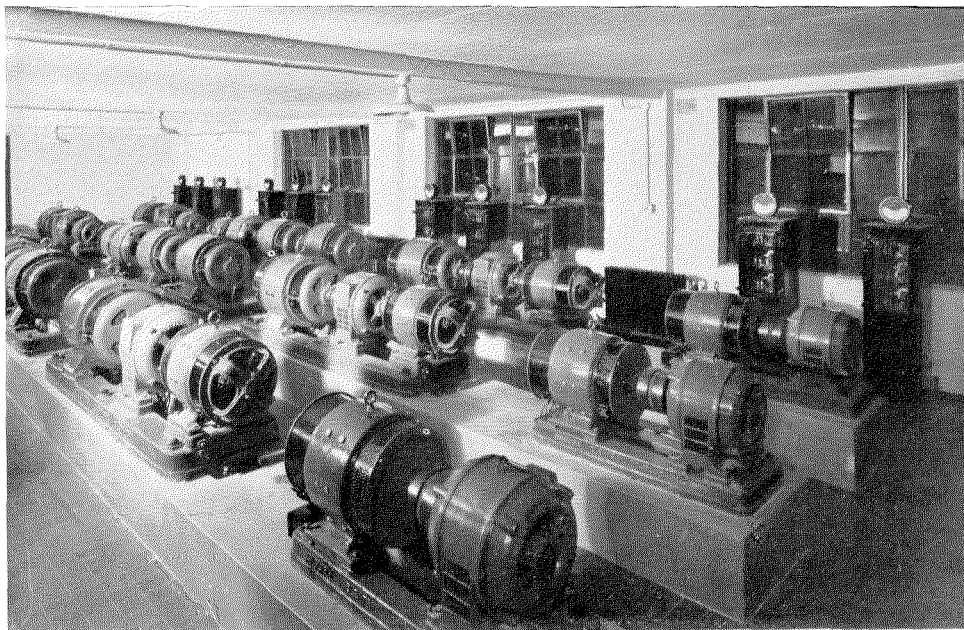

Figure 7—Motor Generator Sets with Starters in Background.

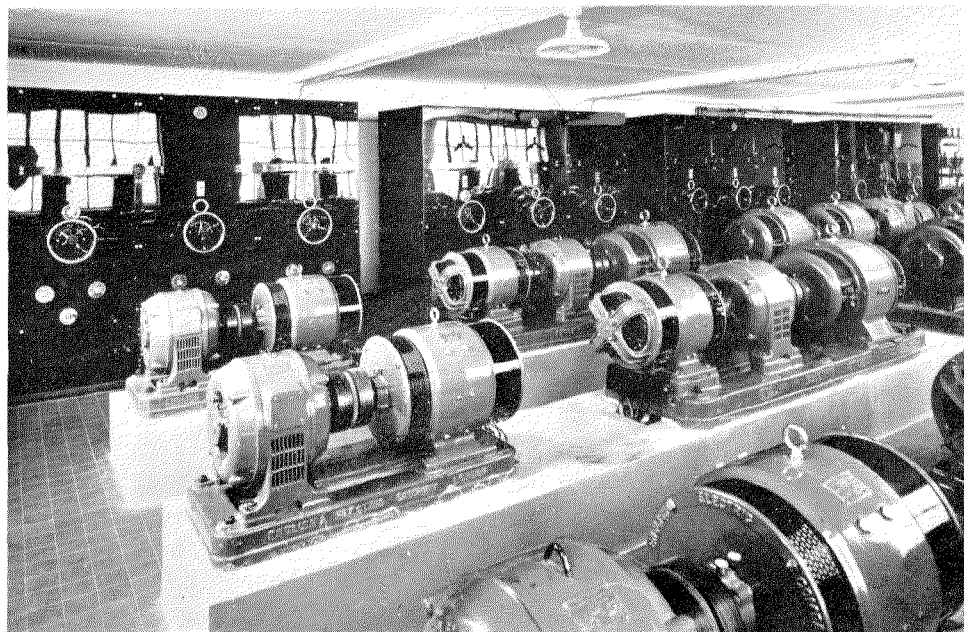

Figure 8—Motor Generator Sets Showing Transfer Switchgear Behind.

frequency to that required for radiation. It is not economic to grind crystals to the low wavelengths required for short-wave broadcasting. Crystals are, therefore, made to operate on some sub-multiple of the required frequency. Three stages of multiplication may be used if desired. The last multiplier stage drives the modulated amplifier consisting of two 250-watt valves. The modulation system is also contained in this unit. The output of the line amplifiers is transformer-coupled to two valves in push-pull. This stage is capable of handling approximately double the power required for the modulated amplifier. The depth of modulation is accordingly not restricted by any limits imposed on the modulator valves. The frequency characteristic of this stage will determine the overall frequency characteristic of the transmitter, since there can be no question of side-band cut-off on these wavelengths, and this characteristic does not vary by more than 2 decibels between 50 and 8000 cycles.

The third, fourth and fifth units are radio-frequency power amplifying stages. Each stage

steps up the power by approximately the ratio 6:1. The small power step-up ratio greatly adds to the ease with which the transmitters may be tuned on any wavelength.

The full advantages of the unit type of construction are well illustrated in this transmitter. Access may be obtained to both sides and the back of each unit by means of doors and removable panels. Only the radio-frequency circuits with their essential apparatus are housed in units, all the control relays, smoothing circuits, etc., being external. Certain mechanical features present interesting points. The units themselves are made of duralumin with polished slate front panels and nickel fittings, presenting a remarkably pleasing appearance. All insulators are made either of Pyrex or Mycalex as the heavy dielectric losses at these frequencies prohibit the use of the more usual insulators, such as bakelite, phenol fibre, etc.

Control and Operation of Transmitters

Two of the most important features of the Empire Station are the centralisation of control

and the safety precautions which have been taken. The latter have been carried out in accordance with the most modern power practice, resulting in the use of mechanical interlocks throughout the system.

The main control board carries all the regulators for the necessary filament, grid bias and high tension supplies for both transmitters. In addition, safety circuits and their associated relays, alarm circuits, etc., are fitted to the back of this main board. Behind this, and forming part of it, are the two main rectifiers for supplying high tension for the last two stages of power amplification.

Isolating fuses enable faults to be quickly located on any control circuit. The front panels of the control boards are polished black slate, lining up with the radio-frequency units in appearance.

The argument is sometimes put forward that this centralisation of control, involving as it does additional apparatus, renders the plant more

liable to breakdown. However, it has the advantage, important in the particular case under consideration, of making the starting up or shutting down of a transmitter a matter of a few minutes only. Furthermore, failures, if such do occur, are of a minor nature and may be quickly rectified.

In addition to the protection of important and costly apparatus by automatic alarm circuits, etc., the safety of the operating staff has been given the utmost consideration. The system of mechanically interlocking all doors with an isolating switch, as well as providing an electrical interlock, renders the danger to personnel absolutely negligible. It is not possible to have access to any dangerous voltage without isolating the voltage supply and earthing the components in question. Each radio cubicle and the entrances to the two control boards are fitted with this mechanical isolating and earthing switch.

Under the heading of the operation of the transmitter must be considered wavelength

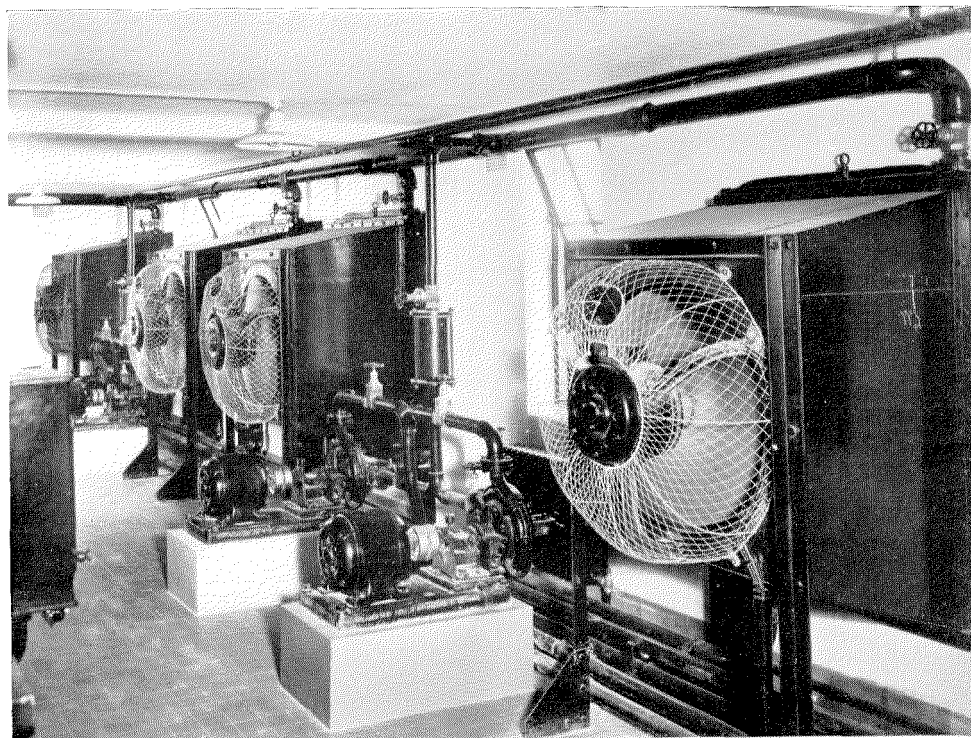

Figure 9—Water Cooling Plant.

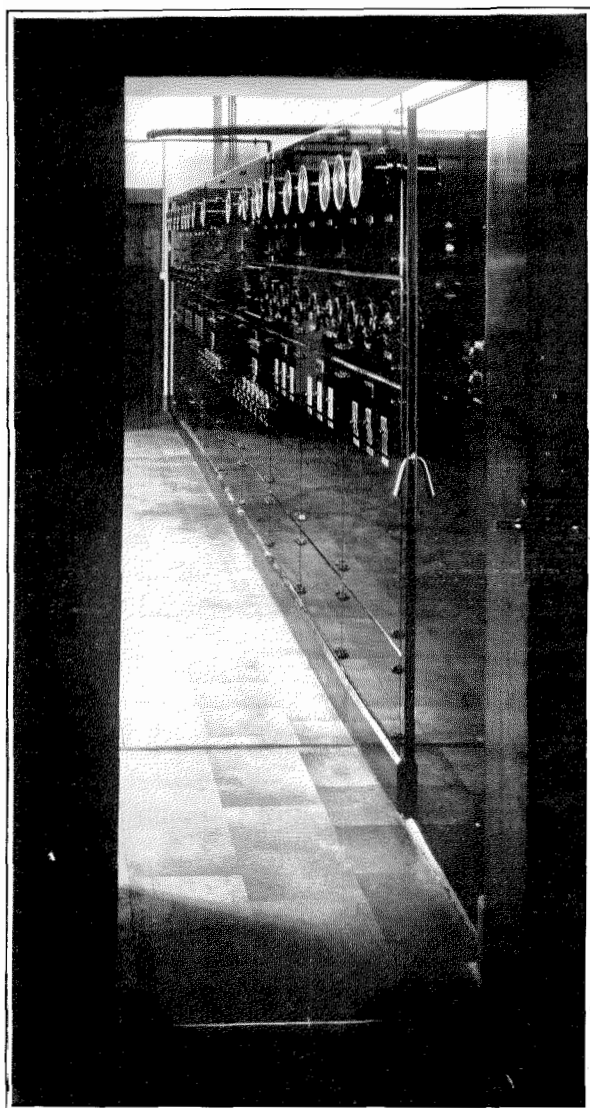

Figure 10—The Main Control Board Centralising the Control of All Apparatus in the Building.

changing. It is not possible, due to the number of octaves covered, to have circuits which may be tuned by a variable capacity alone and, therefore, the inductances for each tuned circuit are made in the form of detachable coils. To change the wavelength it is necessary to change the inductances in each of the radio-frequency circuits; the fine adjustment of these circuits being obtained by variation of capacity. The heavy loading of the grid circuits and small power step-up ratios between the radio-frequency amplifiers

enables the wave change to be made rapidly, since it is not necessary to line up the working conditions of each unit with the extreme accuracy usually associated with the high power frequency amplifiers. The latitude allowable in the adjustment of the controls of these transmitters is definitely a feature of the installation.

In order that the lining up of the transmitter may be correct on modulation, a meter (a recently developed type of peak voltmeter) is connected to the modulated amplifier stage giving a direct reading of the percentage modulation. The complete operation of shutting down the transmitter, changing wavelength and starting up again occupies two operators about ten minutes.

Power Supplies

Fig. 13 shows how the main incoming a-c. supply is transformed down to the required voltages and distributed to the apparatus. It will be noticed that there are two separate supplies in the building, one at 220 volts feeding the lighting system, crystal oscillators and the line amplifying apparatus, and the other at 415 volts supplying the transmitter plant, the object being to prevent any possible overloads on the main equipment that might affect the lights or the low power equipment. Complete isolation of either transmitter may be effected by the operation of a single oil breaker which is interlocked with its own main control board.

The supply to the building is 3-phase, 50 cycles at 10,500 volts; after being stepped down to 415 volts this is converted to the correct d-c. voltage for the filaments, grid bias and high tensions by motor generator sets. The exception is the high tension for the second and third radio-frequency amplifiers, obtained from a double 3-phase thermionic rectifier. The motor generator sets are arranged in three rows (see floor plan), each row providing the complete supplies for the transmitter, the third acting as a standby. The a-c. supply to the motors, the output of the generators and the control circuits, may be switched to either transmitter by the transfer switchgear in the generator room; these switches are mechanically interlocked to eliminate mistakes. The control (starting, stopping and excitation) is normally effected at the main control board but, for maintenance purposes,

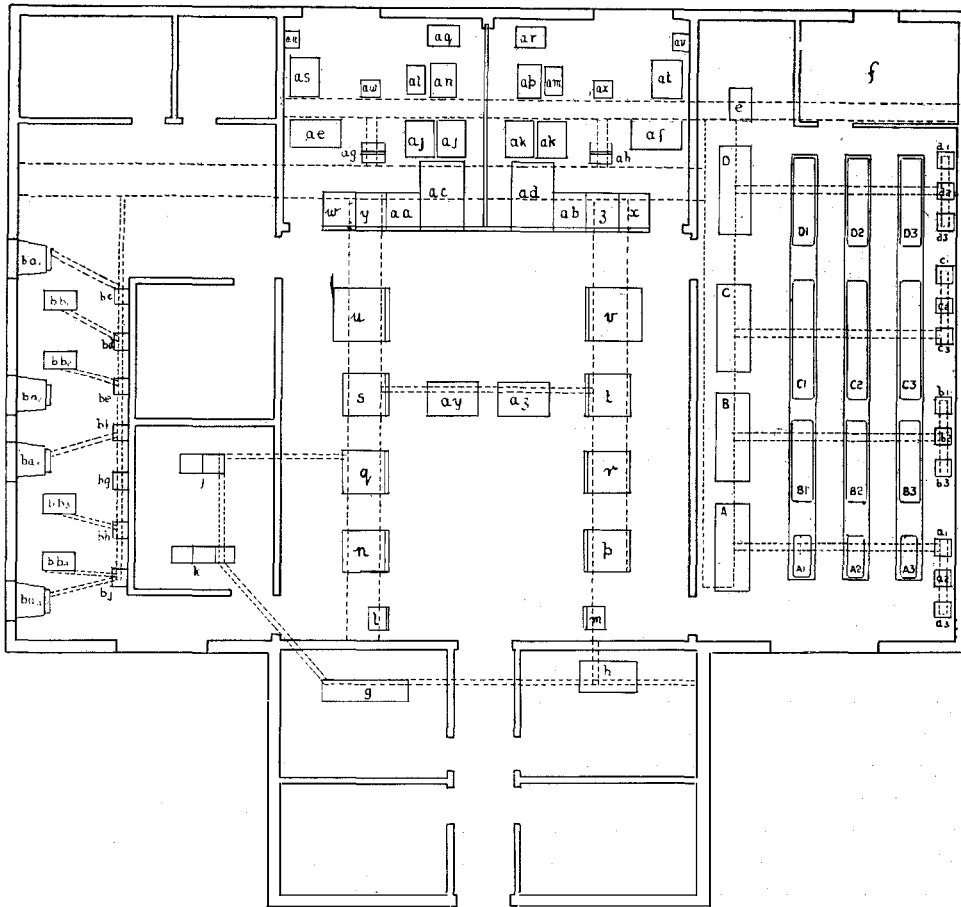

DESIGNATIONS

- A - TRANSFER SWITCH FOR 275V GENERATOR.
- AL2A3 275V GENERATOR
- Q1,Q2,Q3 STAR-DELTA STARTER FOR AL2A3 RESPECTIVELY
- B - TRANSFER SWITCH FOR 16V 1000V & 1500V GENERATOR
- B1,B2,B3 16V, 1000V & 1500V GENERATORS.
- b1,b2,b3 STAR-DELTA STARTER FOR B1,B2,B3 RESPECTIVELY
- C - TRANSFER SWITCH FOR 16V, 2500V & 2500V GENERATOR
- C1,C2,C3 16V, 2500V & 2500V GENERATOR.
- c1,c2,c3 STAR-DELTA STARTER FOR C1,C2,C3 RESPECTIVELY
- D - TRANSFER SWITCH FOR 24V & 275V GENERATOR
- D1,D2,D3 24V & 275V GENERATOR
- d1,d2,d3 STAR-DELTA STARTER FOR D1,D2,D3 RESPECTIVELY
- e OIL BREAKER SWITCH FOR TRANSMITTERS 1&2
- f SUB-STATION, INCOMING SUPPLIES
- g SPEECH INPUT EQUIPMENT.
- h CONTROL DESK FOR SPEECH INPUT EQUIP
- j RECTIFIERS FOR SPEECH INPUT EQUIPMENT
- k SMOOTHING RACKS FOR SPEECH INPUT EQUIPMENT

- | | | |
|-------|--------|--|
| TRANS | TRANS. | |
| N1 | N2 | |
| l | m | CRYSTAL OSCILLATOR. |
| n | p | OSCILLATOR MODULATOR UNIT. |
| q | r | INTERSTAGE AMPLIFIER |
| s | t | 1ST POWER AMPLIFIER |
| u | v | 2ND POWER AMPLIFIER |
| w | x | POWER BOARD N1 |
| y | z | POWER BOARD N2 |
| aa | ab | POWER BOARD N3 |
| ac | ad | RECTIFIER UNIT |
| ae | af | HT SMOOTHING RACK |
| ag | ah | GRID BIAS POTENTIOMETER |
| aj | ak | HT TRANSFORMERS |
| al | am | CHOKO COIL N1 |
| an | ap | CHOKO COIL N2 |
| aq | ar | INTERPHASE REACTOR |
| as | at | INDUCTION REGULATORS |
| au | av | CONTROL BOARD FOR INDUCTION REGULATORS |
| aw | ax | EHT CONTACTOR BOX. |
| ay | az | CONTROL DESK. |

- ba, ba2, ba3, ba4, COOLING FANS & RADIATORS.
- bb, bb2, bb3, bb4, PUMPS
- bc CONTROL CONTACTOR BOX FOR PUMPS & FANS
- bd STARTER BOX FOR FAN ba
- be - - - PUMPS bb & bb2
- bf - - - FAN ba2
- bg - - - FAN ba3
- bh - - - PUMPS bb3 & bb4
- bj - - - FAN ba4

Figure 11—Floor Plan of Empire Broadcasters.

facilities are provided for this to be done independently at the transfer switch cubicles of either transmitter. The outputs of the generators are fused at the transfer switch cubicles.

Water System and Cooling Plant

A closed water system provides cooling for the anodes of the valves. Distilled water is forced round the system by centrifugal pumps and is cooled by air-blast coolers. Electrical isolation for the anodes of the valves is effected by the use of rubber hose coils. All connections, where the possibility of electrolysis exists, are made of antimonial lead which resists chemical action which might be set up due to the liberation of either nascent hydrogen or oxygen. The pumps are in duplicate; the system operates normally with three or four fans running.

Installation and Testing

Preliminary work on the Empire Station was begun in January, 1932, and the first six months were occupied with the engineering, manufacturing and preliminary testing of the apparatus. Installation was commenced at the beginning of August and the whole equipment was available for overseas tests on November 14th. The formal opening of the Empire Station took place on the 19th of December, 1932. On Christmas day the King's speech with the special Empire Program was broadcast to the Empire.

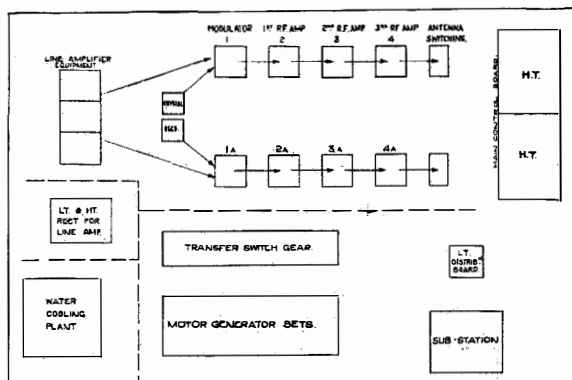

Figure 12—Block Schematic of Twin Empire Broadcasters.

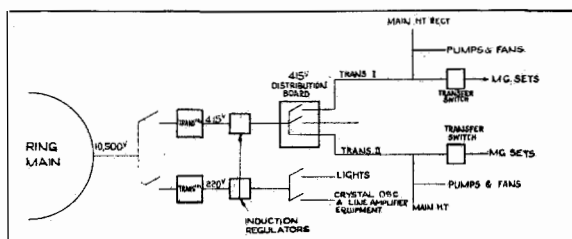

Figure 13—Distribution of Power Supplies on Empire Station.

Reports received from the Colonies on the preliminary tests and early programs indicate that the equipment is more than able to fulfil its function and that the British Broadcasting Corporation is to be congratulated upon its judgment in embarking on this project.

Aspects of Modern Central Office Installation Practice

Bypath System

By L. PALMER

Standard Telephones and Cables, Ltd.

Introduction

IN the development of any system of communication, design and equipment must necessarily evolve with due regard to rapid erection and testing—both of which functions exercise a vital influence on costs. Installation of the larger central office equipments in metropolitan areas accounts for about 12% of the cost of the equipment, but adverse conditions during installation may easily prolong constructional or testing periods and raise the cost to 17% or even 20%.

Modern practice makes available to personnel employed in constructional work many time-saving devices in the way of power driven tools such as electric hoists, drills and hammers, but unless the equipment itself is suitably designed for convenient and rapid handling, these auxiliaries do not contribute much towards cost reduction. It may be of interest, therefore, to examine the conditions which in the writer's opinion are essential to high quality installation, yet inexpensive in relation to the total cost of the equipment.

Of the four major conditions which govern efficient installation, the two most important are:

- (1) Unitised equipment.
- (2) Correct sequence of deliveries of material.

If either one of the above conditions is absent, the orderly progress of the work becomes impeded or difficult to maintain and costs tend to increase.

The remaining two conditions may be stated as:

- (3) Broad limits for electrical and mechanical requirements.
- (4) Trained personnel.

As each of these four governing conditions is perfected, it follows that the trend will be

towards short installation periods and decreased, although more highly specialised, personnel.

There have been numerous instances in the development of established automatic systems where (referring again to the above conditions) Nos. 2 and 4 have been satisfactorily met, but the failure of Nos. 1 and 3 have sufficed to prevent an anticipated reduction in installation cost from being realised.

The advent of Bypass is of particular interest in this connection, since the system in its fundamental design offers all the facilities which are contributory to rapid and inexpensive installation. It certainly meets conditions Nos. 1 and 3, being highly utilised and containing an invaluable asset to simple installation, viz., one type of switch, the mechanism of which is easily detachable for check inspection. The more delicate relay equipment is panel-mounted and is arranged to be jacked-in on the bays, thereby providing ideal facilities for testing and shipping either on or off the bay. (See Figs. 1 and 2.)

A fact which in the past has not perhaps been sufficiently appreciated is that system design which favours economic installation is conducive as well to low manufacturing costs—the reason being that in many respects the function of installation is little more than a continuation of the manufacturing process.

Planning of Deliveries and Personnel

One of the major problems in planning an installation for a minimum cost and period is to determine the economic personnel load in relation to the output of material. Both factors—personnel and material—are so closely interlinked that if either falls even slightly out of balance, it invariably produces an increase in cost with perhaps a prolongation of the schedule period.

Correct sequence of delivery is, therefore, of vital importance in securing the desired result,

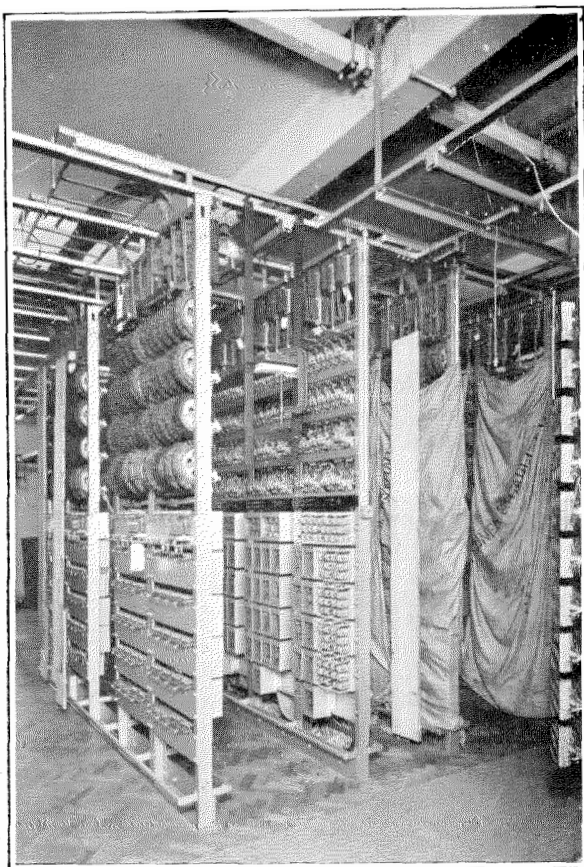

Figure 1—Penultimate Bays Erected.

and since output of material is dependent upon shop capacity and the period required for manufacture, it follows that the scheduling of every detail of the equipment must be revertive to the stage at which it is engineered or ordered.

In modern practice this actually takes place, reference being given in the equipment specification to the particular shipment group within which each item of material is assigned. A chart (Fig. 3) illustrates the relative grouping of processes from start to finish of a typical step-by-step central office installation, together with material in sequence of shipment order. It will be observed that the period over which shipments are made for installations of from 3000-6000 lines is 45% of the total period. The peak of the personnel load should occur at 30% and should not continue beyond 40% of the total period; thus, the composition of each individual shipment is a controlling element in the progress of installation and, of course, its cost.

Each shipment group on Fig. 3 constitutes a unit of installation for which personnel of a certain type and grade is required. It is a function of installation planning to ensure that the personnel is available and also to maintain a correct balance between the number of cable layers, wiremen and testers. Failure to do this results in congestion, with consequent loss in performance realisation, and this is especially noticeable if the process of wiring is delayed and becomes superimposed on the process of testing.

That constructional work should be completed before functional testing commences is an axiom of efficient installation practice and to this end it is necessary to plan the maximum personnel



Figure 2—Penultimate Bays Being Raised from Case.

load in accordance with Fig. 4, which also shows the relative periods during which the various grades of personnel are required.

The Process of Erection

It has been emphasised that the degree of unitisation of equipment has a marked bearing upon the cost of installation; therefore, an examination of those features of Bypass development which have contributed to its practical realisation may be of interest.

The unit of Bypass equipment is the bay. Bays vary in width but the average dimensions are 2 feet by 11.6 feet, and the weight is 500 pounds. This is a matter of interest from the viewpoint of installation as regards strength and type of lifting tackle required, particularly when it is remembered that a unit of equipment which

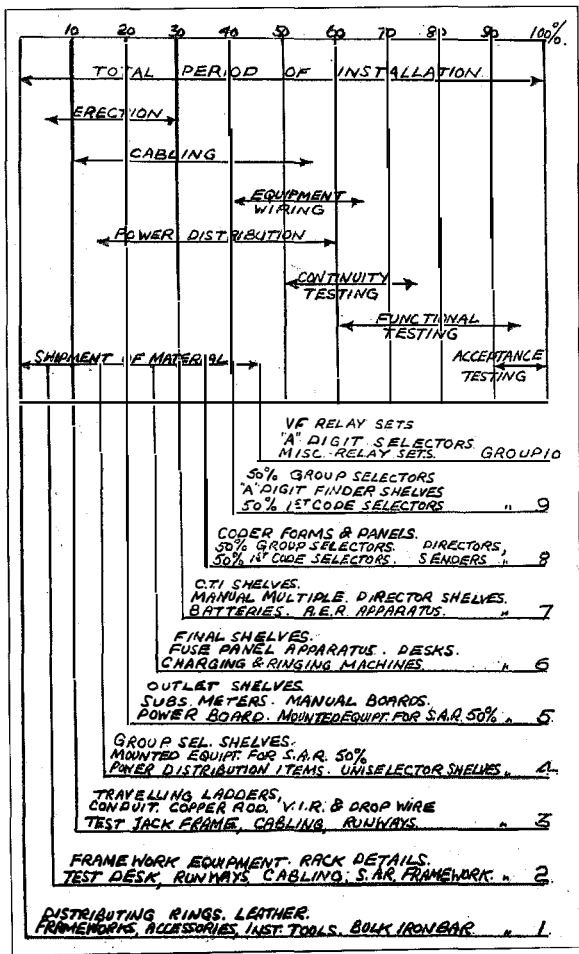

Figure 3—Sequence of Shipment Chart.

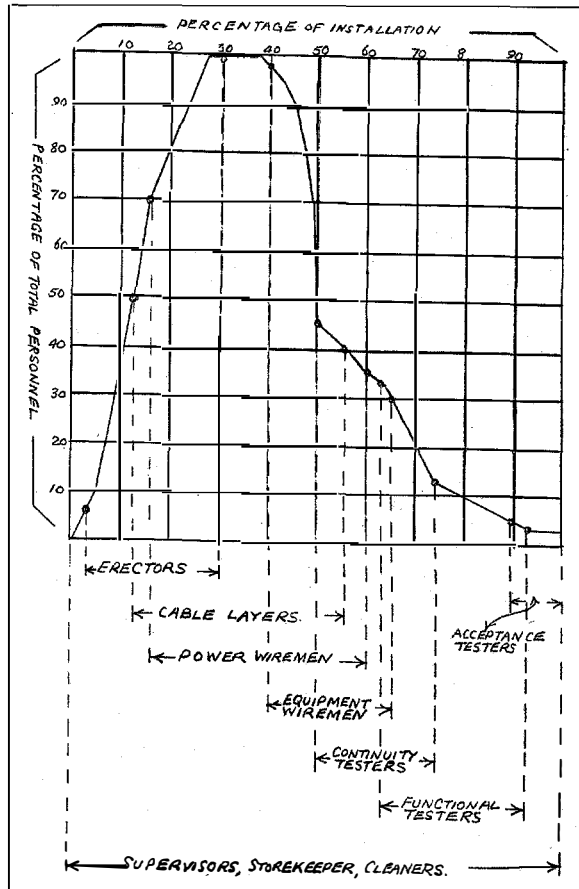

Figure 4—Personnel Load.

is excessively heavy or large may present extreme difficulties of handling in the narrow gangways which are inevitably found in a metropolitan exchange where space is valuable.

The bays are anchored at the top to a light angle iron which forms part of the superstructure framework used as a support for cable racks, ladder tracks, lighting equipment, etc. At the foot, the bay rests on an angle detail which serves as a means of floor fixing and also as a weight distributor.

In Fig. 5 the superstructure and base angles are clearly visible, also several triangular base footings which support temporary channel uprights holding the superstructure in position where no bays are equipped.

The advantage of a system in which the basic design permits the erection of superstructure ironwork and cabling to be completed before the

bays of equipment are erected is overwhelming, since once these processes are finished most of the risk of accidental damage to equipment by cabling and erection personnel, heavy scaffolding and dust, is eliminated.

Manufacturing departments also benefit by this form of design as the equipped bays may remain in the shop under test and adjustment until the installation has advanced at least 40% of its total period.

An interesting method of moving bays from the landing platform in the switchroom to the position assigned or a particular row is illustrated in Figs. 2, 6 and 7. It was desired to handle the bays rapidly and smoothly and with consideration to the fact that little head room existed between the top of the bay framework and the superstructure (already in position). This clearance was so small that it was impracticable to use any ordinary form of trolley for the movement of the bays. The method evolved was both cheap and efficient and will have wider application than to Bypass bays alone.

Strips of sheet steel with wood runner guides on either side were laid on the floor along the route from the landing platform to the position assigned to the bay on the rack. The upper surface of the steel sheet was slightly greased and the bay having been stood upright was slid along to its rack position. The process was simple and gave unusually good facilities for turning the bay in a restricted space; moreover, weight was of no importance as the greasy surface of the steel strip provided ease of movement. It also obviated bumping, which is inseparable from any form of movement with the use of a trolley.

The Process of Cabling

This item is subject to extremes of variation both in respect of the total quantity of cable used and to the cost of laying and forming. The amount of cable required is governed by the type and disposition of the plant and this latter variable is in turn affected by the height of the building. It is, however, possible to estimate the cost of cabling for a given system such as Rotary, Step-by-Step, Manual, and so on—providing a normal plan of layout is assumed—by equating the number of subscribers' lines to the trunking elements in the system. On this basis

of computation, it is significant that the cost of cabling a metropolitan Bypass office is slightly more than half the cost for an equivalent step-by-step office.

Performance results obtained from a series of manual and step-by-step installations show that the process of cabling absorbs:

32% of Total Cost of Installation for Manual.

21% of Total Cost of Installation for Step-by-Step.

Bypass requires an allowance of 12%.

The high percentage in the case of a manual office is almost entirely attributable to the multiple and, in some further degree, to the dissociated arrangement of equipment.

The comparison between Bypass and step-by-step reflects clearly the saving arising from Bypass circuit concentration combined with a more convenient access to bay terminals.

In a Bypass office, all equipment used in the

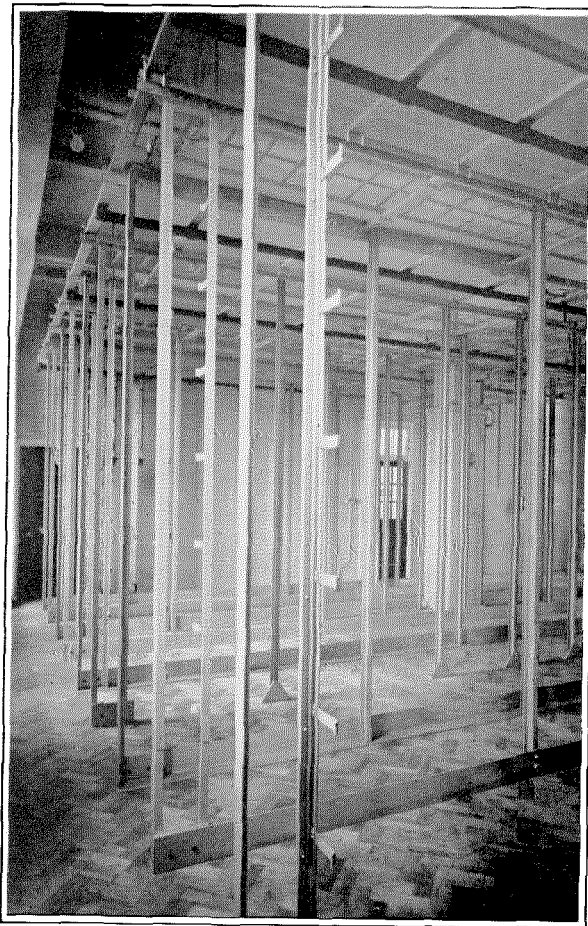

Figure 5—Framework.

switching train for local, incoming and outgoing circuits is bay mounted and consequently requires only a normal terminal strip connection at the top of each bay. This degree of standardisation greatly facilitates cabling as well as the preparation of wiring information and since the method of fanning wiring is generally adopted, the cost of forming is negligible.

The provision of a superstructure framework over the area of the automatic equipment materially assists the process of cabling as it provides a convenient support for auxiliary racks and fixtures and also for the suspension of scaffolding used by cabling personnel, thus freeing the floor space of supports. Fig. 1 shows the end of a run of scaffolding on an adjustable hanger. (The protective buffer has been removed from this hanger to show the bay equipment.)

In Fig. 8 may be observed a rather curious effect at Advance Exchange, London. Here, full advantage was taken of the Bypass layout—the whole of the cabling serving the bays and I.D.F. being completed with the ends stripped and waxed before the first bay was placed in position. This plan gave material saving in cost because the cabling personnel had exceptional freedom of access and were for once relieved of the stigma of being the principal cause of damage to switch-gear, etc.

The Process of Testing

Among other matters in which installation practice varies as between one authority and another, none provides more active discussion than the scope and character of the tests which are applied during the process of installation. This divergence of opinion is frequently apparent in the actual method of making the test and to some extent this may be accounted for by considerations entirely outside the province of installation.

One such controlling element, of course, lies in the design of the system. Where circuit combinations or the association of equipment favour a simplified form of field test, the general testing plan (and number of personnel) is quite different from the case in which circuit design or equipment layout requires the installer to impose more elaborate tests or to increase the number of sectional tests.

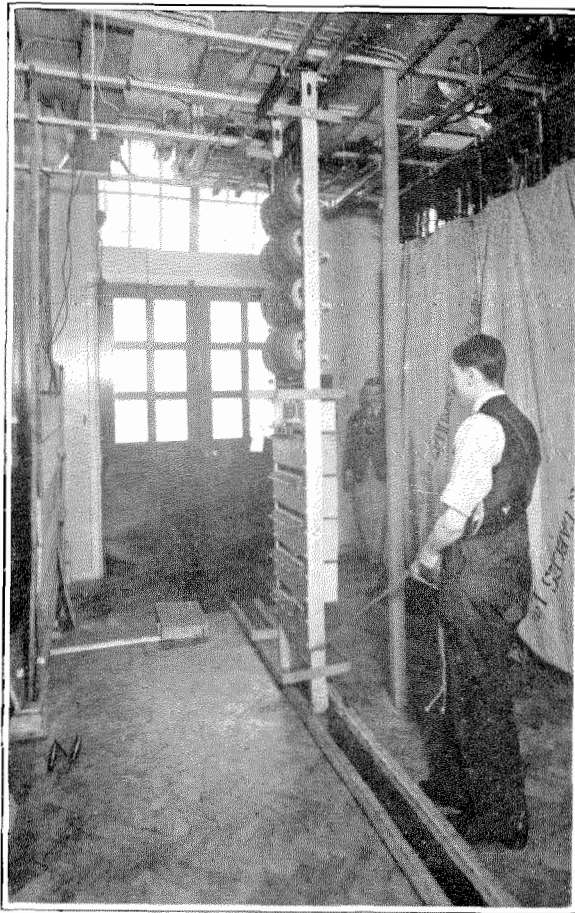

Figure 6—Bay in Movement.

Again, there are what may be termed “manufacturing limitations”—the period during which the product can be economically held in the shop may restrict the amount of testing applied at this stage. But these questions apart, there are others of a controversial nature which depend on the particular policy of an installation department. The following two are typical and are selected for brief comment:

- (a) Design of installation test sets.
- (b) Field adjustment of apparatus.

(a) Design of Installation Test Sets

If the entire range of installation test sets is examined, it will be found that the types of sets fall into two general classes:

- (1) Measuring instruments for current, voltage and insulation tests.
- (2) Functional test sets used for checking circuit operation.

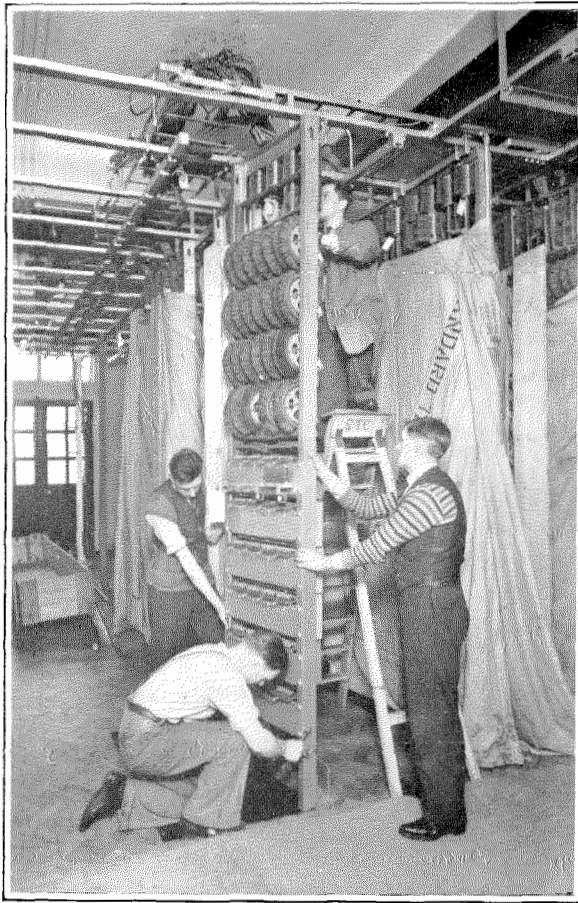

Figure 7—Bay Being Erected.

It is this latter group which offers a wide latitude in respect to design because a functional test may be restricted to proving the operating condition of a few circuits or it may be extended to larger circuit combinations. Furthermore, the design of the set may incorporate semi-automatic operation as in the case of the subscribers circuit routiner (Fig. 9) or it may be arranged for manual control. Whichever of these alternatives is adopted, there can be no doubt at all that the conditions which should govern the design of installation test sets are:

- (a) Portability.
- (b) Simplicity of the test set circuit.

There can be no reason other than misdirected effort for the production of a complicated test set. Where this tendency does exist, it is usually as a result of combining too many tests in one set, or in making insufficient use of the facilities

afforded by the exchange equipment itself as an auxiliary to the test set.

The Bypass marker multiple test set (Fig. 10) exemplifies a form of design in which full advantage has been taken of the "jack-in" feature of the Bypass equipment as the test set, when in action, replaces a normal Bypass panel, no test trolley or support fixture being required. This set also makes use of the path switches of the exchange equipment in making its tests and is automatic in operation.

(b) *Field Adjustments of Apparatus*

This phase of the testing process illustrates perhaps better than any other example the advantage to be gained in the overall result by the closest cooperation and understanding between the Installation Department and Manufacturing Department, since the degree of accuracy attained by the Manufacturing Depart-

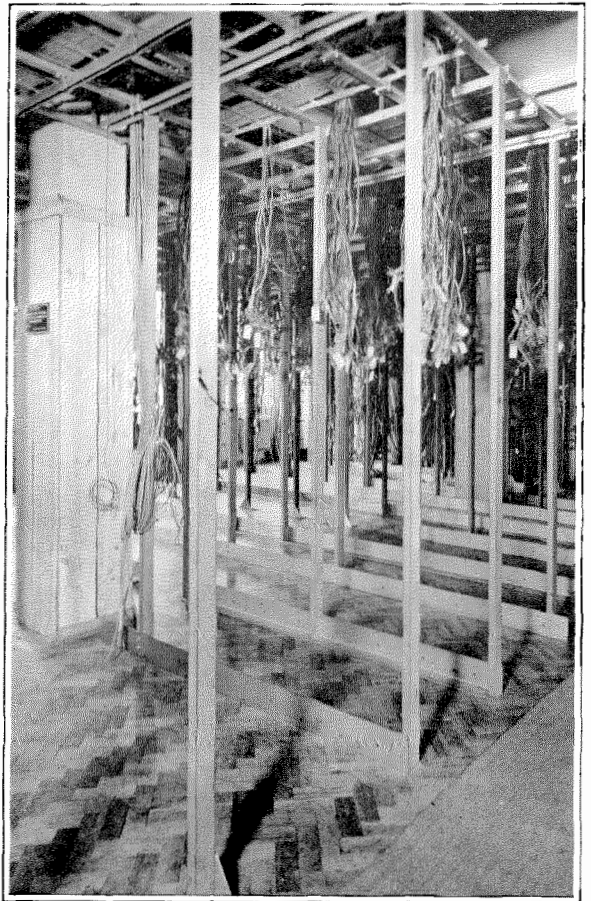

Figure 8—Complete Cabling.

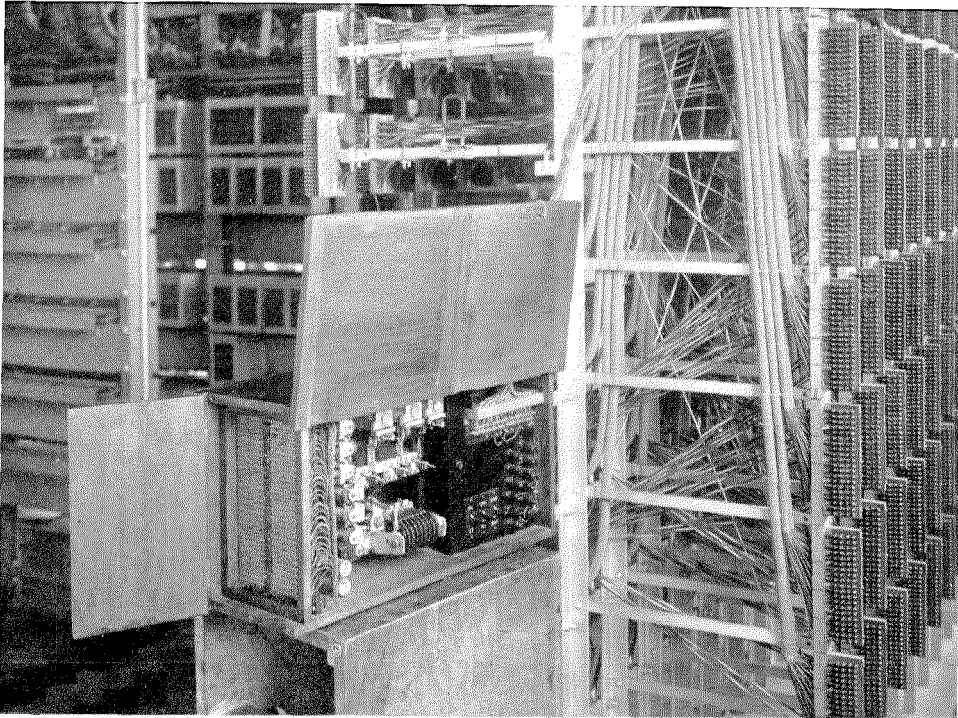

Figure 9—Subscribers Circuit Router.

ment in meeting the prescribed requirements for apparatus adjustment must govern the character and amount of readjustment to be imposed by the installation testers. What, then, is to determine the condition of apparatus adjustment to enable it to pass inspection in its manufacturing stage so that the field personnel will not need to make laborious and expensive check inspection to ensure a condition of acceptancy? The writer holds that the only sure and complete answer lies in the provision of dual limits for all electrical and mechanical requirements. This is not an innovation in telephone engineering practice, but it is questionable whether full advantage is always obtained from these dual limits while the product is progressing through its various manufacturing stages.

In Fig. 11, two examples of dual limits are illustrated, from which it will be seen that the more exacting limit is that to which the apparatus must respond up to and including the stage

of final shop inspection. If this condition is rigidly observed and the more severe adjustment is applied in the initial process of assembly, it will ensure response to within the less severe limits during the functional test in the field.

In the writer's opinion, apparatus should not require readjustment by field personnel except for repair or damage—in fact it may well be argued that necessity for readjustment during installation is an indication of the manufacturing process being incomplete or of unsatisfactory design. In the latter category, it is interesting to compare in Fig. 12 the wide limits of adjustment which have been provided in the Bypass system with others less satisfactory in the step-by-step system.

The question of adjustment viewed broadly is one of vital consequence to installation performance results and for this reason extreme care is necessary to secure the correct form of adjustment when this is applied in its initial stage, as a

spring may be incorrectly set by an inexperienced operator and still retain its tension long enough to pass manufacturing inspection although it may fail to pass the field test.

Training of Personnel for Circuit Testing

The technique of installing equipment for any system of communication calls for specialisation in various directions among the personnel employed. Technical proficiency is obviously necessary for all forms of system circuit testing and, while a sound knowledge of operational principles is usually demanded in the higher grades of constructional personnel, the qualification is not as essential to this class of employee as the ability to control men and costs and take common sense decisions on innumerable small problems of administration.

In installation departments opinions vary as to the relative status within the organisation of the expert technician versus the experienced installer, but in the view of the writer there is no

doubt at all that the former should be subordinate to the latter. This statement should not be understood to imply that the function of installation does not encourage specialisation in circuit technique, but rather that a form distinct from that required in the circuit laboratory is demanded. For example, the installation tester is seldom called upon to decide a problem involving switch or relay design—such questions are clearly for the laboratory engineer. Conversely, the diagnosis of faults observed on system tests is directly within the province of the installation tester and is therefore handled more expeditiously by him than by the circuit expert with little or no installation experience.

The foregoing will serve to emphasise the need of special training in fault location for circuit testers required in the installation field.

Actually, the practice is to select personnel who have already reached a standard of proficiency in constructional work. Nominees in this class are then examined for general technical

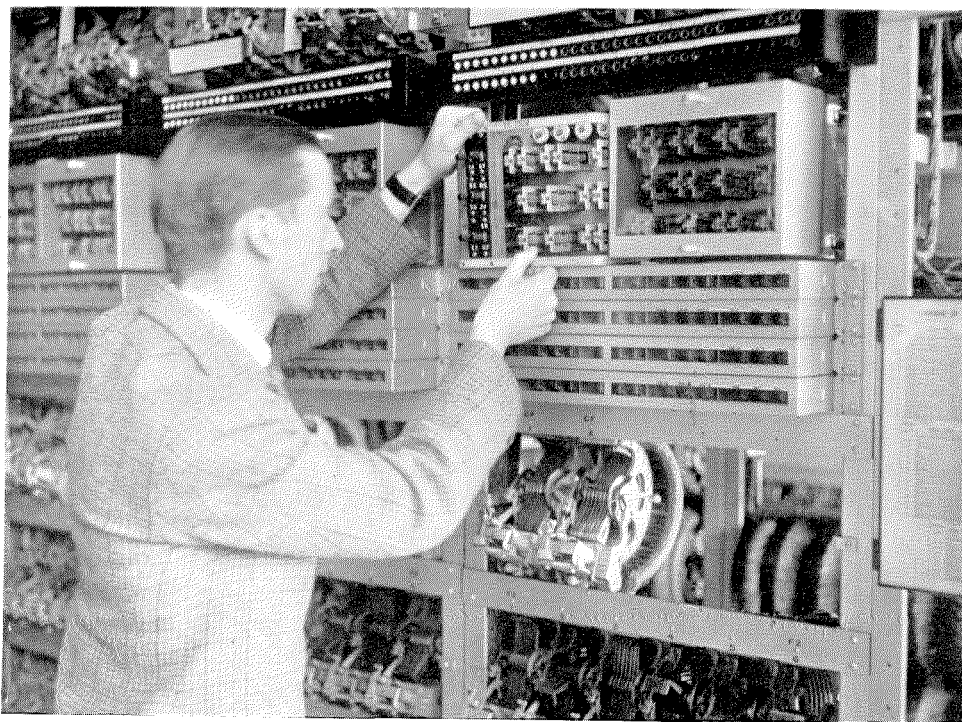

Figure 10—Marker Multiple Test Set.

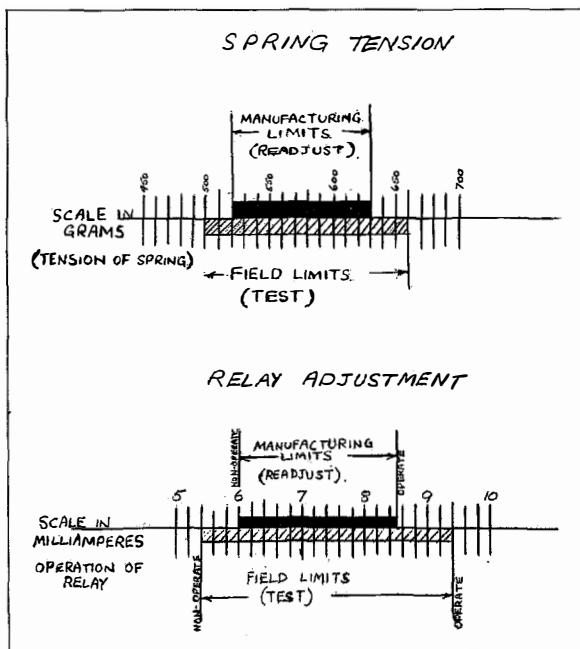

Figure 11—Dual Adjustment Limits.

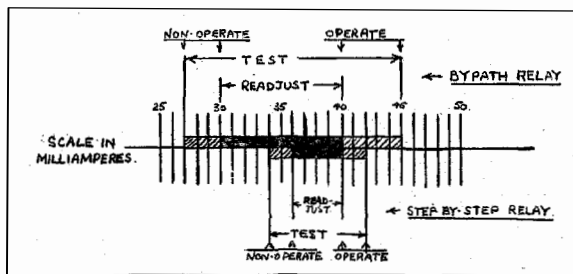

Figure 12—Comparative Adjustment Limits Step-by-Step v. Bypass.

qualifications as a preliminary to receiving special training in a circuit school. For personnel required to handle system tests where it is essential for the tester to appreciate the interdependence of one group of circuits upon another as, for example, in rural automatic networks, the writer prefers the use of a graphical method of circuit analysis as the basis of tuition. Briefly, this method is as follows:

The student testers are first instructed in the principles of the trunking scheme and also in the function of the apparatus used.

The circuits are then analysed in the form of an operational chart, a specimen of which is shown in Fig. 13 with the schematic from which it is produced in Fig. 14.

In class work, such as is generally adopted for the training of testers, the circuit operation charts or graphs can, of course, be prepared and presented to the students as a complete representation of the circuit operation. These charts are then copied and retained by the students and can be used for future reference far more readily than any other type of circuit description.

For the reading or study of the more complicated schematics which are supplied in what is known as the "detached contact" form, a further expedient is necessary in order to simplify the task and save time. This expedient takes the form of a table or index which is first prepared giving the square location of all relay coils and contacts on the schematic. The schematic is divided into squares of suitable size, depending upon the congestion of the drawing, and the

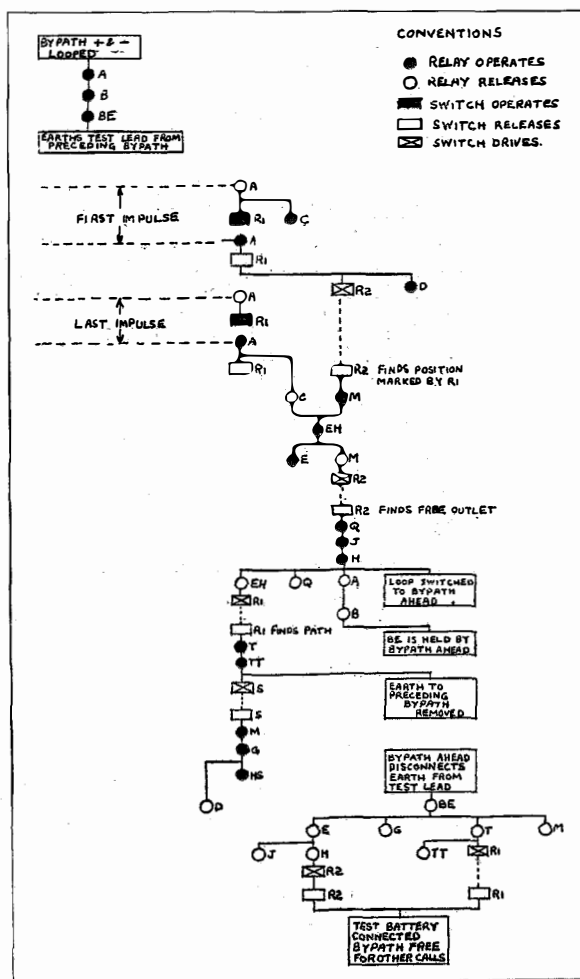

Figure 13—Operational Chart.

squares are lettered downwards and numbered from left to right. In this way any relay coil or contact can be found immediately by reference to the index and the effect of the operation or release of any relay can be explored with comparative ease.

The advantage of the use of circuit operation charts or graphs of the type indicated in the illustrations may be summarised as follows:

- (1) The chart presents in an abbreviated form a clear picture to the mind of the student of the sequence of operations.
- (2) It provides a ready means of reference at any time and, particularly during the initial period of circuit study, it enables the student to determine whether relays are in the operated or non-operated position.
- (3) From the point of view of the instructor, the operation chart is an invaluable aid:
 - (a) It facilitates the presentation of the sequence of operation in a manner which is simple to grasp and which could hardly be dealt with in any other way.
 - (b) It establishes a perfect chronological order of events and enables time relationships to be realised and discussed with great ease.
 - (c) It provides a very ready means of checking the progress of the students, and their efforts at circuit reading can be scrutinised thoroughly and quickly.
- (4) For individual circuit study or analysis, either when examining the circuits in the initial stages or when dealing with faults, the operation chart is particularly helpful:
 - (a) It allows the student to record his conclusions with certainty and brevity.
 - (b) When clearing faults, the ready reference to the details of the circuit operation which the chart provides results in considerable saving of time.

Conclusion

The review of installation activities covered by the preceding sections of this paper is necessarily

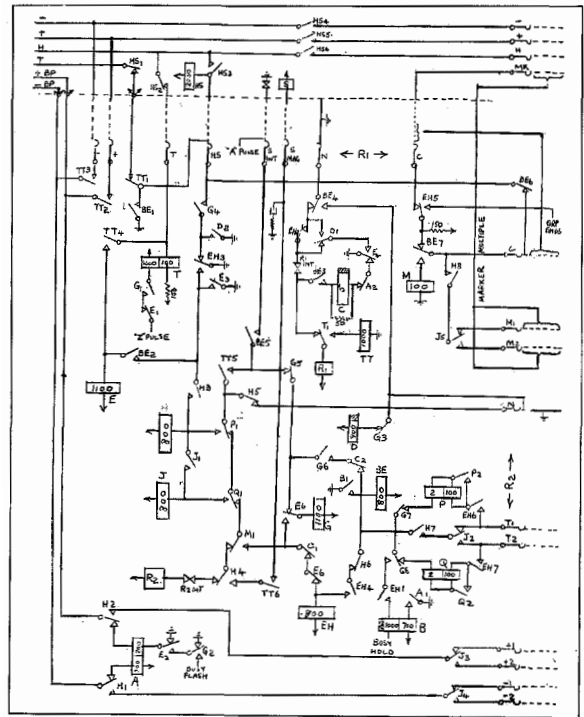

Figure 14—Schematic for Operational Chart.

incomplete. Major functions of estimating, constructional methods and administrative routine have received little attention, but the writer hopes that it has been made sufficiently clear how much the result of installation effort depends upon engineering practice and production. In the case of the former, it can be stated that a system in which the design favours efficient installation is also one which costs least to maintain. As regards the latter, the whole purpose of intelligent production in its relation to the function of installation may be summed up in one single phrase: "The right material in the right quantity, at the right time."

Fundamental Plan, 1931—1950

Buenos Aires and Suburbs

By RICARDO T. MULLEADY, B.Sc. and C. G. BARKER, A.C.G.I., M.I.E.E.

Introduction

THE United River Plate Telephone Company, an associate company of the International Telephone and Telegraph Corporation, was among the earliest privately owned concerns in the world to undertake commercial development of the telephone. Local exchange service was established in Buenos Aires in 1883, when the capital of the Argentine was just a large colonial village of some one thousand blocks in size, with a population interested principally in cattle raising and agriculture and with no important international commerce. Buenos Aires in those days presented that distinctive aspect that the Spanish people gave to all the towns they founded in the Southern Continent, characterized by the well-known uniform block layout with chess-board appearance, cut by

straight narrow streets running at right angles from north to south and east to west.

Today the capital of the Argentine is a modern city with more than 2,000,000 inhabitants, developing along a well thought-out modern city planning scheme, which is modifying by steps the original layout. The narrow streets are being widened and the monotonous chess-board disposition of the blocks is being cut by diagonal avenues, along which the building of skyscrapers is changing the general appearance of the city.

The fact that Buenos Aires in 1883 had an area of 39 square kilometres with practically no suburban population, and that at present the Federal Capital covers an area of 185 square kilometres with a suburban population extending over 1,500 square kilometres, indicates how rapidly the Capital and its surroundings have grown in importance; the city of Buenos Aires being at pres-



Figure 1—Plaza Once and Rivadavia Street in 1880.



Aerial View of Buenos Aires Showing Plaza de Mayo and the United River Plate Building in the Foreground

ent in population the largest in the Southern Hemisphere and the second largest Latin city in the world; the first being Paris with some 3,000,000 inhabitants.

Fig. 1 depicts the Plaza del Once in 1880, a public square where the farmers' carts that brought provisions to the town from the west used to park; and Fig. 2 shows the same Plaza at present, the long distance telephone office and "Cuyo" local automatic office being situated a few blocks from this Plaza, today the heart of the densest area in the city.

In the early stage of its telephone history, the

Buenos Aires area consisted of several small manual C. B. offices located in the downtown section, near the river shore. As the town developed from the riverside to the north, south and west, numerous small offices were opened at the wire centres of the local neighbourhoods where the population had grouped, and suburban magneto offices were also opened in the garden villages surrounding the Capital. With the progress of the telephone art and in response to the demand of the public for a more efficient service, the United River Plate Telephone Company, always ready to adopt the latest approved prac-

tices, early dedicated serious consideration to the conversion of the Buenos Aires manual offices to automatic. As a result of these studies, in 1923 four automatic exchanges were cut over in the Federal Capital.

A fundamental plan was made for the city in 1924, covering a period of ten years, and the first automatic offices inaugurated under that plan were opened in 1927. This fundamental plan did not, however, take into consideration some of the latest developments in the telephone art, such as modern telephone sets with improved transmitters, the zoning of instruments, and the improved equivalents in inter-office trunks brought about by modern loading. Consequently there arose the necessity for a long-period study, taking into consideration not only modern equipment and methods, but also the vital necessity of compiling basic information founded on a careful block-to-block commercial survey. Thus, a new fundamental plan study was commenced in 1930.

In the preparation of a fundamental plan of such magnitude involving, as it does, the anticipated telephone service requirements of one of the world's leading urban concentrations over a

twenty-year period, it is understood that there are many technical and economic details that have taken considerable time to be worked out and to be scheduled. It is not, however, the intention of this paper to give technical and economic details, but merely to present a general picture of past conditions, present layout, and the projects for the future; these last being based on a conservative commercial forecast.

The Fundamental Plan for the period 1931–1950, covers the provision of telephone plant in Buenos Aires and suburbs, and is based on a line and station growth, as indicated by a block-to-block commercial survey made in 1930–1931.

Inasmuch as the forecasting of telephone development on this continent has little background for guidance, it was thought desirable to compare the survey figures with corresponding figures arrived at independently by means of the "saturation" method, using the basic data provided by the Official City Planning Bureau of the Municipality.

In general, the line and station growth indicated by the "saturation" method follows reasonably close to those future requirements



Figure 2—Plaza Once and Rivadavia Street at Present.

TABLE I.
INCREASE OF POPULATION OF BUENOS AIRES 1855—1914.

| Year | Population | Increase Over Previous Counting | | Annual Increase Over Period | |
|------|------------|---------------------------------|-------------------|-----------------------------|------|
| | | Inhabitants | % | Inhabitants | % |
| 1855 | 85,500 | — | — | — | — |
| 1865 | 150,000 | 64,500 | 75.5 for 10 yrs. | 6,450 | 7.5 |
| 1876 | 200,000 | 50,000 | 33.3 for 11 yrs. | 4,545 | 3.0 |
| 1886 | 400,000 | 200,000 | 100.0 for 10 yrs. | 20,000 | 10.0 |
| 1887 | 455,000 | 55,000 | 13.7 for 1 yr. | 55,000 | 13.7 |
| 1895 | 664,000 | 209,000 | 45.9 for 8 yrs. | 26,100 | 5.7 |
| 1904 | 951,000 | 287,000 | 43.2 for 9 yrs. | 31,800 | 4.8 |
| 1909 | 1,232,000 | 281,000 | 29.5 for 5 yrs. | 56,200 | 5.9 |
| 1914 | 1,576,000 | 344,000 | 27.9 for 5 yrs. | 68,800 | 5.6 |

indicated by the block-to-block survey, and since its results, intimately associated with the population of the city, throw interesting light on the past and expected future development of the town, it is thought preferable in this publication to show in tables the saturation figures associated to the population figures, rather than the survey information.

Municipal records show that Buenos Aires has grown in population from 1855 to 1914, when the last census took place, according to the figures in Table I.

For the year 1925, the Municipal statistics gave Buenos Aires a population of some 1,800,000 inhabitants, and it is estimated that the urban population in 1932 was about 2,100,000, with 2,400,000 inhabitants included in the metropolitan or combined urban and suburban areas.

From figures published by the Municipality, the information in Table II is taken regarding

TABLE II.
ESTIMATED POPULATION OF BUENOS AIRES 1925—1950
RATE OF INCREASE 2% PER ANNUM.

| Year | Population | Increase in 5 Years | Annual Increase |
|------|------------|---------------------|-----------------|
| 1925 | 1,800,000 | | |
| 1930 | 1,987,000 | 187,000 | 37,400 |
| 1935 | 2,195,000 | 208,000 | 41,600 |
| 1940 | 2,420,000 | 225,000 | 45,000 |
| 1945 | 2,675,000 | 255,000 | 51,000 |
| 1950 | 2,952,000 | 277,000 | 55,400 |

the predicted growth of the city of Buenos Aires up to 1950. The net rate of growth is 2% and the starting population is 1,800,000 inhabitants in 1925.

The district known as the Federal Capital has a total area of about 18,500 hectares, and can comfortably accommodate 3,000,000 inhabitants with an average of 162 per hectare, a density which is less than the average found in the largest cities of the world, such as New York, with 442; London, with 166; Paris, with 365; and Berlin, with 332.

Central Office Distribution

The City of Buenos Aires has at present twenty-seven central offices, distributed in twenty-two buildings, of which twenty-one are automatic, five manual C. B. and one magneto multiple in the modest district known as Mataderos.

Table III gives the estimated population of Buenos Aires, distributed by central office areas, at 1950, the estimated population density by hectares, and the area of each office in hectares as included in the present boundaries.

Out of the 18,500 hectares, 1,110 correspond at present to public gardens and parks, and it is anticipated that this area will be increased considerably in the future, a reservation of 13% of the total area of the Federal District having been allowed in the municipal city planning schemes for enlarging existing parks and opening new ones.

Lines and Stations

Reliable information with regard to the number of stations is available from 1885. The development in terms of subscribers' lines beginning with that year is shown in Table IV.

On the basis of the population of Buenos Aires registering a net growth rate of 2%, as forecast

TABLE III.
ESTIMATED POPULATION OF BUENOS AIRES (FEDERAL
CAPITAL) IN 1950. DISTRIBUTION BY EXISTING
CENTRAL OFFICE AREAS.

| Central Office Area | Esti- mated Density | Area—Hectare | | Inhabi- tants |
|---------------------------------|---------------------------|--------------|-----------|------------------|
| | | Total | Effective | |
| Barracas..... | 220 | 820 | 620 | 180,400 |
| Avenida..... | 280 | 250 | 150 | 70,000 |
| Retiro..... | 73 | 600 | 150 | 44,000 |
| Buen Orden.... | 240 | 550 | 460 | 132,000 |
| Mayo-Libertad- Rivadavia.... | 370 | 290 | 280 | 108,000 |
| Juncal-Plaza... | 212 | 600 | 390 | 167,200 |
| Cuyo..... | 370 | 280 | 280 | 103,600 |
| Corrales..... | 135 | 1,690 | 1,400 | 228,000 |
| Loria..... | 290 | 300 | 260 | 87,000 |
| Mitre..... | 295 | 340 | 290 | 100,300 |
| Palermo..... | 180 | 1,120 | 670 | 201,600 |
| Caballito..... | 230 | 700 | 630 | 161,000 |
| Darwin..... | 165 | 740 | 690 | 122,100 |
| Belgrano-Pampa | 185 | 1,080 | 930 | 200,750 |
| Flores-Volta.... | 140 | 1,280 | 1,150 | 180,400 |
| Paternal..... | 145 | 670 | 650 | 97,150 |
| Urquiza..... | 140 | 1,330 | 1,160 | 186,200 |
| Núñez..... | 101 | 810 | 710 | 82,000 |
| Floresta..... | 140 | 1,290 | 1,240 | 180,600 |
| Devoto..... | 145 | 1,160 | 940 | 168,200 |
| Mataderos..... | 40 | 1,870 | 1,800 | 74,800 |
| Liniers..... | 110 | 730 | 700 | 80,500 |
| | | 18,500 | 15,550 | 2,955,800 |

by the municipal authorities, with population at the various periods shown in Table II, it is estimated that the number of lines per one hundred inhabitants will increase from 6.09 to 13 in a period of twenty years (1930-1950). Table V gives the estimated number of lines Buenos Aires will have at the various periods under consideration and Fig. 3 shows curves giving the development for both the saturation methods and the commercial forecast.

The final results agree closely under both methods of estimating, the saturation method giving 390,000 lines for a population of 3,000,000 inhabitants, and the commercial forecast some 396,400 lines, corresponding to a density of 13.0 and 13.2 lines per one hundred people, respectively, as indicated by the curve in Fig. 4. Considering the rapid progress made by Buenos Aires in the last fifteen years and the fact that one of the characteristics of the Argentine people is to rapidly incorporate all modern commodities in their standard of life, it is anticipated that in the future an increasingly greater use will be made of telephone service, and consequently these figures cannot be considered overestimated but rather, conservative.

Central Office Locations and Boundaries

The telephone area of Buenos Aires and suburbs is at present served by sixty-two offices, distributed over approximately 1,500 square kilometres. Of the sixty-two offices, twenty-seven are within the Capital boundary, as per list given in Table III, and thirty-five are in the suburbs.

Careful investigations involving consideration of existing duct and cable network, building capacities and density of telephone traffic were carried out to determine whether it would be economically possible, not only to reduce the number of central offices, but to concentrate all the city-to-suburb and intersuburban traffic in one tandem office, to be located in the same building as the toll office. The result of this investigation proved that it would only be possible to make some alterations to the existing layout in the city, but that in the suburbs several central office areas could economically be consolidated.

One of the main reasons that prohibited a fundamental change in the Capital central office layout was the fact that the office equipment and a large portion of the outside plant were relatively new. If it had not been for these two factors, especially the advanced state of conversion to automatic, housed in relatively new buildings, a greater freedom for recasting areas would have been possible; however, the population density plan of Buenos Aires indicates that the present offices are still located at virtually the wire centres of the zones and these, as far as it can be foreseen, will not vary appreciably in the future.

Buenos Aires has grown considerably during

TABLE IV.
DEVELOPMENT OF BUENOS AIRES CITY EXCHANGE
AREA, 1885-1931.

| Year | Lines | Population | Lines per 100 Inhabitants |
|------|---------|------------|------------------------------|
| 1885 | 2,115 | 380,000 | 0.55 |
| 1890 | 3,600 | 533,300 | 0.67 |
| 1895 | 4,200 | 664,000 | 0.63 |
| 1900 | 7,698 | 823,000 | 0.93 |
| 1905 | 11,298 | 1,007,200 | 1.12 |
| 1910 | 16,300 | 1,300,800 | 1.25 |
| 1915 | 28,500 | 1,590,000 | 1.79 |
| 1920 | 42,000 | 1,700,000 | 2.47 |
| 1925 | 73,200 | 1,800,000 | 4.07 |
| 1930 | 120,404 | 1,987,000 | 6.09 |
| 1931 | 126,894 | 2,024,400 | 6.25 |

The number of stations at the end of 1931 was 150,970.

TABLE V.
TELEPHONE FORECAST 1930—1950. SATURATION METHOD.

| Year | Population | Rate of Increase | Expected Lines | Increase—5 Years | | Annual Increase | |
|------|------------|------------------|----------------|------------------|------|-----------------|------|
| | | | | Lines | % | Lines | % |
| 1930 | 1,987,000 | 10.4 | 120,400 | — | — | — | — |
| 1935 | 2,195,000 | 10.5 | 171,500 | 51,100 | 42.4 | 10,220 | 8.48 |
| 1940 | 2,420,000 | 10.3 | 230,800 | 59,300 | 34.6 | 11,860 | 6.92 |
| 1945 | 2,675,000 | 10.5 | 301,500 | 70,700 | 30.6 | 14,140 | 6.12 |
| 1950 | 3,000,000 | 12.0 | 390,000 | 88,500 | 29.4 | 17,700 | 5.88 |

the last twenty-five years, but it has grown by expansion of the city proper, which is the lower part of the town near the river, and of what are called "barrios"—zones of dense population concentrated at the centres of the Municipal parish divisions,—and it will take some time before all the barrios expand to form a uniform large area, closely built up, as is found in cities of smaller size or in cities at present more densely populated such as New York, Paris and Berlin.

By looking at the layout map of Buenos Aires shown in Fig. 6, it would appear that the central office boundaries assigned do not follow a definite plan, but on the other hand, if it is considered that the present offices are located at the centres of the local barrios, which are, of course, the wire centres of the zones receiving service, and that these barrios are expanding in concentric zones, the present locations of the offices and boundaries seem to be justified.

A very satisfactory and economical layout for the future requirements has been obtained by introducing slight modifications in the boundary lines of the present central office areas, adjusting these to suit the capacity of the existing buildings and their extensions. In the downtown portion of the city there is sufficient building accommodations and ducts to cover the twenty-year requirements, with small additions and modifications; consequently, the existing offices will remain as they are, adjusting only the boundary lines.

Mitre C. B. office, now out of centre, will be replaced by Gomez automatic office with 40,000 lines ultimate capacity, giving relief to adjacent areas by an adjustment of boundaries.

In the outer part of the town no rearrangement in the boundary lines of the existing areas has been found necessary. In the suburbs, the telephone development follows the railway lines and,

as in the case of the Capital, population is disposed in barrios around the railway stations; and it has been the practice in the past, forced by transmission limitations, to provide each suburban town with a separate office. With better telephone sets now available, and the introduction of trunk loading, it has been found economically possible to combine various small offices into one, and these consolidations have

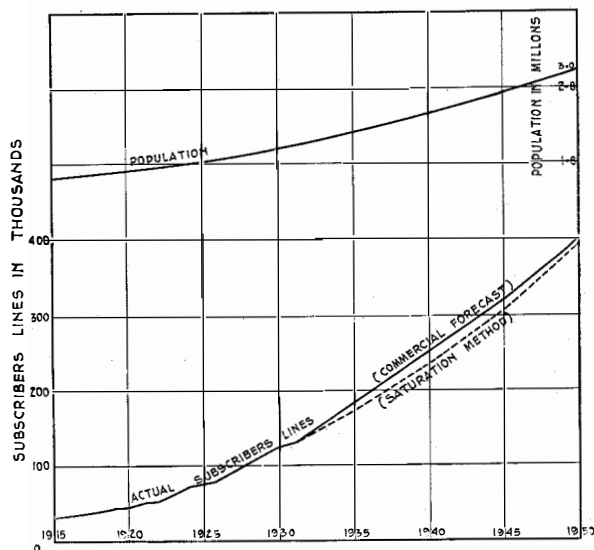

Figure 3—Increase of Population and Telephone Lines in Buenos Aires for the Period 1915-1950.

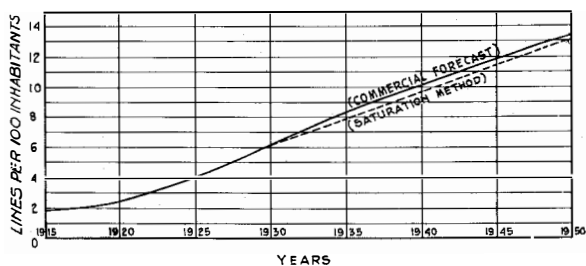

Figure 4—Telephone Lines in Buenos Aires per Hundred of Population for the Period 1915-1950.

been provided for in the general layout. It has thus been possible to combine Vicente Lopez with Olivos, San Isidro with Martinez, Ramos Mejia with Haedo and San Justo, Echeverria with Monte Grande and Ciudadela with Liniers; active consideration is being given to the change of system in the small offices for unattended automatic equipment, to reduce the operating costs.

Figs. 5 and 6 show the existing office boundaries in the Capital in 1915 and those proposed under this study for 1950. The part served by Avenida, Retiro, Mayo, Libertad and Rivadavia offices, known as the city proper, is densely

populated and the buildings prevailing are those types designed for modern business offices, shops and tall apartments. It is in this area where vertical growth rather than horizontal development is anticipated, consequently, the boundaries assigned to the telephone offices cover small areas in comparison with those of other central offices which extend beyond.

It is anticipated that substantial development will take place from east to west along the areas served by Cuyo, Mitre, Caballito, Flores and Floresta, leading to the western suburbs, and from south-east to north-west, along the areas served by Plaza, Palermo, Belgrano and Nuñez,

TABLE VI.
DISTRIBUTION OF 396,400 LINES IN BUENOS AIRES EXCHANGE AREA.

| Office | Lines Working at End of 1931 | Increase Coefficient for 1950 | Lines Estimated at End of 1950 (Comm. Survey Figures) | Capacity of Present Building | Final Accommodation Lines | Remarks |
|--------------------------|------------------------------|-------------------------------|---|------------------------------|---------------------------|---|
| Avenida..... | 7,371 | 1.83 | 13,475 | 27,900 | 20,000 | Will take lines from Rivadavia area. Excess of lines to be transferred to Buen Orden area. |
| Barracas..... | 3,619 | 3.07 | 11,182 | 7,600 | 7,600 | |
| Belgrano-Pampa..... | 7,584 | 2.08 | 15,808 | 9,500 | 16,000 | Building will be extended. After extension will take part of the Barracas area. |
| Buen Orden..... | 6,748 | 2.58 | 17,400 | 17,100 | 23,700 | |
| Caballito..... | 7,392 | 3.45 | 25,412 | 16,200 | 30,000 | Building will be extended. Building will be extended. |
| Corrales..... | 3,360 | 5.12 | 17,188 | 7,600 | 7,600 | |
| Cuyo..... | 9,016 | 2.96 | 26,686 | 19,000 | 19,000 | Excess of lines to be transferred to Loria and Gomez areas. |
| Darwin..... | 5,231 | 4.23 | 22,138 | 15,500 | 15,500 | Building will be extended. |
| Flores-Volta..... | 6,545 | 2.91 | 19,059 | 9,500 | 25,000 | Building will be extended. |
| Floresta..... | 4,533 | 4.07 | 18,459 | 6,200 | 19,000 | Building will be extended. |
| Juncal-Plaza..... | 12,883 | 2.44 | 31,425 | 19,000 | 28,500 | Building to be extended and excess of lines will be transferred to Retiro and Gomez areas. |
| Lib.-Mayo-Rivadavia..... | 16,344 | 2.33 | 38,108 | 28,500 | 28,500 | Excess of lines to be transferred to Avenida and Retiro. |
| Liniers..... | 1,418 | 5.00 | 7,092 | 1,500 | 10,000 | New building required. |
| Loria..... | 4,343 | 4.05 | 17,527 | 14,300 | 28,500 | After extension, will take part of Cuyo and Mitre areas. |
| Mataderos..... | 739 | 5.81 | 4,293 | 1,000 | 6,000 | New building required. |
| Mitre (Gomez)..... | 5,213 | 3.45 | 18,044 | 6,500 | 38,000 | New building required to replace existing Mitre Office. This office will give relief to Darwin-Palermo-Juncal and Cuyo areas. |
| Nuñez..... | 1,645 | 5.18 | 8,523 | 6,100 | 14,500 | Building extension required. |
| Palermo..... | 8,405 | 3.32 | 27,825 | 19,000 | 19,000 | Extension required. |
| Paternal..... | 3,425 | 4.46 | 15,298 | 6,700 | 19,000 | Extension required. |
| Retiro..... | 5,470 | 2.16 | 11,729 | 12,000 | 18,600 | After extension, will take lines from Libertad-Plaza-Juncal areas. |
| Urquiza..... | 3,086 | 5.30 | 16,284 | 7,600 | 20,000 | Building will be extended. |
| Devoto..... | 2,769 | 4.85 | 13,420 | 6,400 | 12,900 | Building will be extended. |
| Avellaneda..... | 127,139 2,144 | 3.11 3.58 | 396,375 7,680 | 264,700 4,300 | 426,900 9,500 | Building will be extended. |

NOTE: Avellaneda automatic office is situated in the suburbs, although distant 6 kilometres only from Plaza de Mayo. It however forms part of the Capital network and Capital tariffs are charged.

leading to the northern suburbs. The present heavy tramcar transport and general traffic, the proposed underground railways for the future, the cost of the land, and the fundamental studies which the City Planning Commission has made, all seem to indicate that great development with vertical growth will in the future extend along these radial lines, linking up centres which in the past constituted separate barrios and by the widening of streets, give quick access to the large population in the western and northern suburbs.

Fig. 7 shows the territory which is covered by this Fundamental Plan and which will comprise fifty-six offices. The system is at present a combination of automatic and manual C. B. and magneto, the Capital having, as stated, twenty-one automatic offices, five manual C. B. and one magneto multiple; the suburbs having at present one automatic, seven manual C. B. and twenty-seven magneto. When the Fundamental Plan has been completed the Capital will have twenty-seven automatic offices, the six existing manual offices being scheduled for conversion in the near future; and the suburbs will have twenty-nine

offices instead of thirty-five, due to the consolidation of some of the areas.

Table VI gives the capacity of the Capital offices as they are at present, and the modifications required to fit the study to accommodate the equipment required, according to the figures obtained by the commercial survey.

Table VII shows similar information for the suburban offices, these areas having at present some 12,500 lines, not including Avellaneda which, although outside the Capital, is considered a city area. Of these lines, about 40% have already been converted from magneto to C. B.

Loop and Trunk Study

The standards of transmission adopted by the company previous to 1929 were those in general use in the European administrations, when speech was considered commercial if there existed an equivalent of forty-five standard miles between instruments. With the advance of the art, brought about by improved telephone sets, modern loading and amplifiers, forty-five standard miles was no longer considered commercial

TABLE VII.
DISTRIBUTION OF 38,560 LINES IN BUENOS AIRES SUBURBS

| Name of Office | | Lines Working End 1931 | Lines Estimated End 1950 | Capacity of Present Building Lines | Capacity of Final Accommodation Lines | Remarks |
|--------------------------------|-----------------------------|------------------------|--------------------------|------------------------------------|---------------------------------------|---|
| Building Property of Tele. Co. | Building Rented | | | | | |
| Adrogué..... | | 574 | 1,143 | 1,440 | 1,440 | |
| | Banfield..... | 796 | 1,386 | 900 | 2,000 | New C. B. building required, year 1933. |
| Bella Vista..... | | 148 | 339 | 310 | 700 | Modification and reconitioning of building, year 1947. |
| | Berazategui..... | 56 | 210 | 320 | 320 | |
| | Bernal..... | 272 | 980 | 380 | 1,200 | New building required 1935. |
| | Boulogne & V. Adelina..... | | 215 | | 300 | Rented building to be acquired in Boulogne, year 1933. |
| | Burzaco..... | 93 | 243 | 380 | 380 | |
| | Caseros..... | 114 | 489 | 315 | 700 | Remove to new premises, 1940. |
| | Ezeiza..... | 21 | 40 | 156 | 156 | |
| | F. Varela..... | 113 | 290 | 308 | 308 | |
| Florida-V. Lopez..... | | 857 | 7,431 | 1,440 | 8,000 | Building extension, year 1934 for including Olivos. |
| | Haedo..... | 181 | | | | Transfer lines to R. Mejia and close Haedo, year 1934. |
| Hurlingham..... | | 204 | 459 | 280 | 600 | Modifications to building, year 1937. |
| Ituzaingo..... | | 152 | 473 | 355 | 800 | Modifications to building, year 1943. |
| Lanús..... | | 812 | 4,154 | 2,000 | 5,500 | Building modifications, year 1936 and building extension, year 1945. |
| Lomas..... | | 1,490 | 3,400 | 3,300 | 3,300 | Will last till 1949. |
| | Martinez..... | 535 | 4,360 | 535 | 5,000 | New C. B. building, year 1933, to include S. Isidro, year 1934. |
| | M. Grande & Echeverria..... | 135 | 264 | 268 | 268 | |
| Morón..... | | 496 | 1,205 | 1,400 | 1,400 | |
| Olivos..... | | 806 | | 859 | | Transfer lines to Florida V. Lopez, year 1934. |
| | Quilmes..... | 630 | 2,148 | | 2,400 | |
| Ramos Mejia..... | | 463 | 2,138 | 463 | 2,400 | New C. B. building, year 1933, to include Haedo and San Justo, year 1934. |
| San Fernando..... | | 642 | 1,433 | 880 | 2,000 | New C. B. building required, year 1936. |
| San Isidro..... | | 767 | | 900 | | Transfer lines to Martinez and close S. Isidro, year 1934. |
| | San Justo..... | 67 | | | | Transfer lines to R. Mejia and close S. Justo, year 1934. |
| San Martín..... | | 630 | 1,486 | 1,260 | 1,800 | Building extension required, year 1943. |
| San Miguel..... | | 179 | 459 | 355 | 600 | Modifications to building, year 1938. |
| | Santos Lugares..... | 124 | 338 | 340 | 340 | |
| Tigre..... | | 461 | 1,114 | 600 | 1,500 | New C. B. building required, year 1935. |
| | T. Suarez..... | 23 | 60 | 200 | 200 | |
| | V. Ballester..... | 305 | 1,192 | 400 | 1,500 | New C. B. building required, year 1934. |
| | Wiide..... | 112 | 1,101 | 300 | 1,500 | Remove to new premises, year 1937. |
| | Totals..... | 12,258 | 38,550 | 20,644 | 46,612 | |

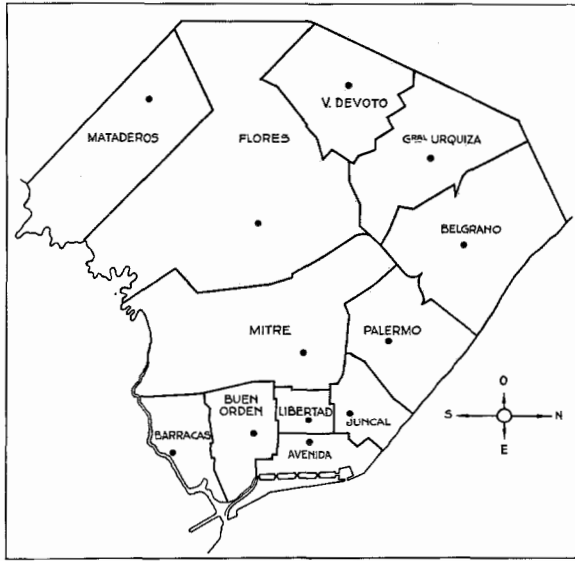

Figure 5—Buenos Aires City Telephone Area Office Locations and Boundaries in 1915.

speech, but very poor transmission; consequently the loop and trunk study for the Buenos Aires area, in combination with the toll fundamental plan study for the whole of the Argentine, had to take into consideration the reform of transmission facilities so as to place the service in this respect upon an entirely improved and modern basis.

Considering the large area covered by the Capital and suburbs with distances as great as seventy kilometres, also that loading was unknown in the system previous to 1929, it is clear that it would not have been previously economical to provide first-class transmission to all the suburban areas, the transmission standard being a variable quantity that oscillated between thirty to forty-five db., according to distances and, especially, the importance of the traffic in the suburban areas.

The introduction of loading in the extensive trunk system serving northern and western suburbs, of heavier gauge cable to the southern suburbs, and of higher quality subscribers' sets has changed fundamentally the grade of suburban service to the extent that in the most important areas subscribers receive better service now than some of the city subscribers received three years ago. These improvements, all in anticipation of the Fundamental Plan Study, are in accordance

with the improved standards of transmission in general use by the associated companies of the International Telephone and Telegraph Corporation, those adopted in the present study being the following:—

- City-to-City service, 18 to 22 db. maximum between instruments.
- City-to-Suburbs, 22 db. maximum between instruments.
- City-to-Toll and Suburb-to-Toll, 7 db. toll terminal loss.
- Suburb-to-Suburb, 24 db. maximum between instruments.

In order to determine the most economical loop and trunk arrangement for the new set-up, comparisons were made of various schemes with uniform loop losses of 4, 6, and 8 db. for all the areas against non-uniform loop losses, the most satisfactory limiting loops found being those indicated on the plan in Fig. 6, where it will be seen that the loops vary from 4 db. for the smaller areas to 8 db. for the larger ones.

With regard to instruments in the Capital and suburbs, practically all the telephones in use previous to 1929, were C. B. and L. B. 4001 sets, British Post Office pedestal and wall types, equivalent to the American 329-20-122 set.

With the introduction to the system of the

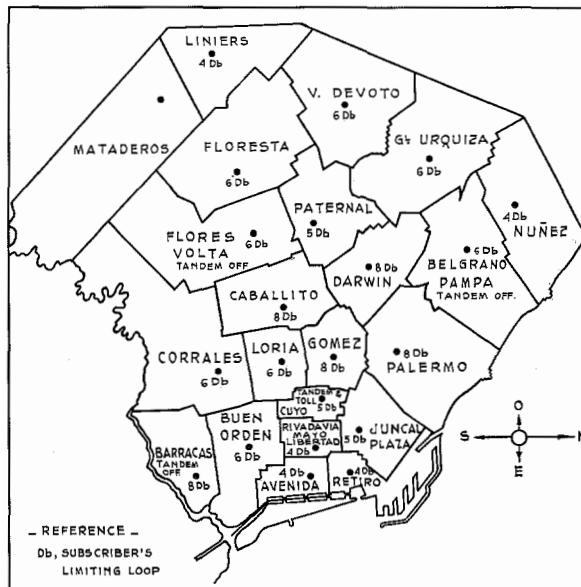

Figure 6—Buenos Aires City Telephone Area Office Locations and Boundaries, Fundamental Plan 1931-1950.

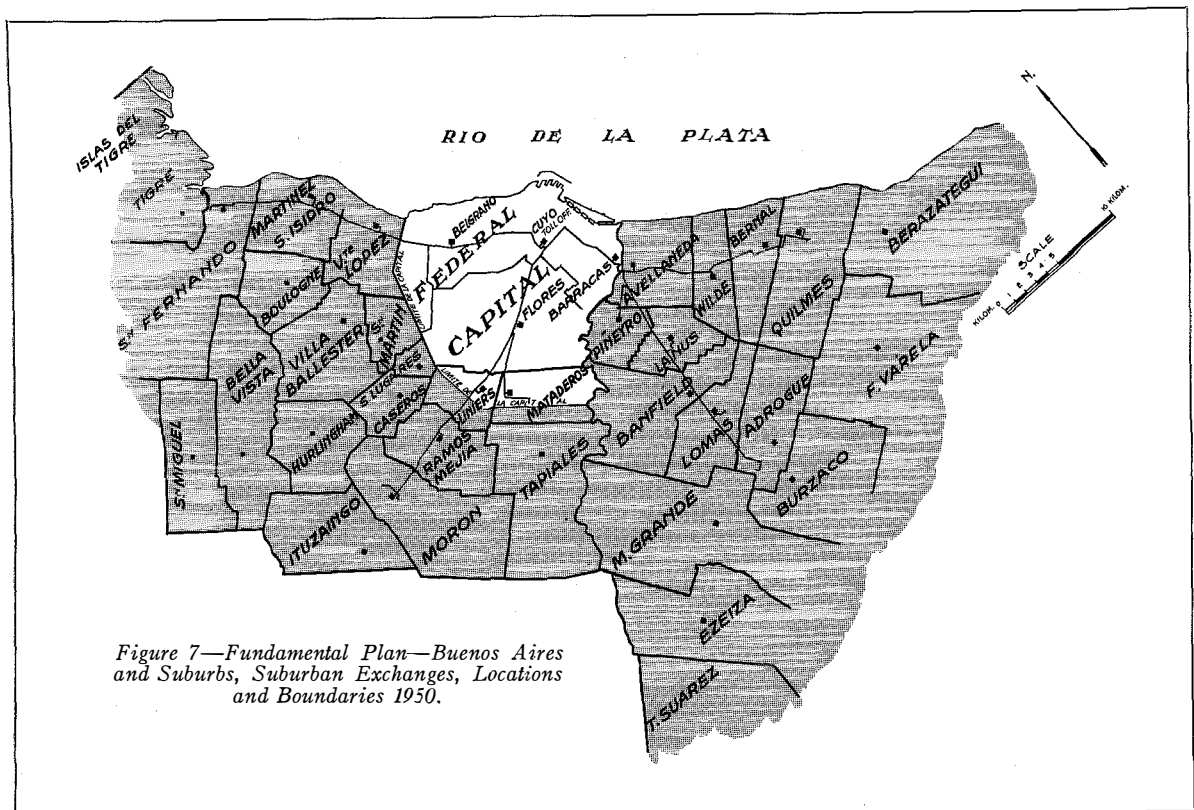

Figure 7—Fundamental Plan—Buenos Aires and Suburbs, Suburban Exchanges, Locations and Boundaries 1950.

modern hand telephone set manufactured by the associated companies of the I. T. and T. Corporation, a considerable number of telephones of this type are now in service, and since the general trend will be later to adopt an improved set, the general use of this type of instrument or a similar one, equivalent to the American 337-46-144 set, has been taken as a basis for the study.

Zone limits for grading the transmission in the Capital are determined on a 24-gauge basis, using three different types of transmitters in order of efficiency; the 4001 B.P.O. type for Zone "A", the No. 2646 with a centrally damped capsule No. 2036-A for Zone "B", and the No. 2647 with a centrally damped conical capsule No. 2037-A for Zone "C". The Antwerp No. 2812 and London No. 4089-A hand telephone sets are being used indiscriminately for the three zones.

Routing of Calls and Tandem Centres

For city-to-city service, the subscriber is to be connected via a direct inter-office trunk joining the two city offices.

For city-to-toll service, the Buenos Aires subscriber is to be connected to the toll office in the

Cuyo building, via a direct toll switching trunk.

For a city-to-suburb call, the subscriber is to be connected through a concentration office via two inter-office trunks, one from the city office to the concentration centre and the other from this point to the suburban office.

For a suburb-to-toll call, the subscriber is to be connected via a direct suburb toll switching trunk joining the suburban office and Cuyo toll board.

For intersuburban service two distinct cases have to be considered: first, for non-contiguous suburbs; and second, for contiguous suburbs. Subscribers in non-contiguous suburbs are to be connected via a direct tandem trunk, from the suburbs to the tandem office at Cuyo building. Subscribers in contiguous suburbs are to be connected either by direct trunks joining the two areas or by two or more intermediate trunks linking up the suburban offices.

For the city-to-city and city-to-toll service, the present arrangement for switching the connections is the same as the future one outlined above. For the suburban service, the present

arrangement of circuits consists, however, of direct lines to the city offices, where more than three trunks are simultaneously occupied during the busy hour, and of concentrated lines for those offices that require less than three trunks during the peak of the traffic.

As the number of lines to the suburbs has increased considerably during recent years, as all the city offices will become automatic in the near future and as we are planning for a long period, all suburban trunks will be more efficiently grouped by concentrating them at convenient points, as a fair proportion of them are at present.

Fig. 8 shows how this concentration will be accomplished; the office of Mataderos, although within the city, will be concentrated as if it were suburban. Furthermore, the full concentration system will allow the suppression of manual operating now existing at the concentration offices, and also the adoption of dialling at the suburban offices. A special study was made to determine whether a single tandem centre would be more economical than a three-tandem arrangement, with negative results, three tandem points hence being adopted.

The final tandem centres will be:

- Pampa:** For Vicente Lopez, Martinez, San Isidro, San Fernando, Tigre, San Martin, Santos Lugares, Villa Ballester and Caseros.
- Flores:** For Mataderos, Ramos Mejia, Morón, Ituzaingó, Hurlingham, Bella Vista and San Miguel.
- Barracas:** For Lanús, Banfield, Lomas, Monte Grande, Ezeiza, Adrogué, Burzaco, Wilde, Bernal, Quilmes, Berazategui and Florencio Varela.

For the suburb-to-toll and suburb-to-suburb services, the existing arrangement is mainly through the concentration centre, whilst in the present study, it is proposed that a tandem office be created in "Cuyo" for intersuburban service, on the same floor as the toll office, with direct tandem trunks to the suburbs.

The direct toll switching trunks from the suburbs to "Cuyo" can also be used for the inter-suburban service for the present until a sufficient number of lines justify a separation. The adoption of direct lines from the suburbs to "Cuyo" toll and tandem offices will do away with the intermediate operators at the existing concentrations, and will eliminate the exchange losses in one office.

Automatic Service—Trunking System

In 1924 the United River Plate Telephone Company adopted for the Capital step-by-step equipment as a result of the Fundamental Plan prepared for the period 1924–1934, and in 1927 the first offices were inaugurated under that plan.

The numbering system at present in use consists of six digits, the first two corresponding to the characteristic and the inter-office trunking taking place between the second and third digits.

With this system, after allowing level "0" for assistance and level "1" for toll and special services, 800,000 are available to cover the 440,000 lines estimated in Buenos Aires and suburbs at 1950.

In the present numbering system, the characteristics are arranged to permit of the concentration of second selectors, the same initial digit being used in the characteristic for offices in the same vicinity.

For the service in the Capital all the offices are connected by direct inter-office trunks; for the city-to-suburb service the plan allows for three tandem centres near the periphery of the town,

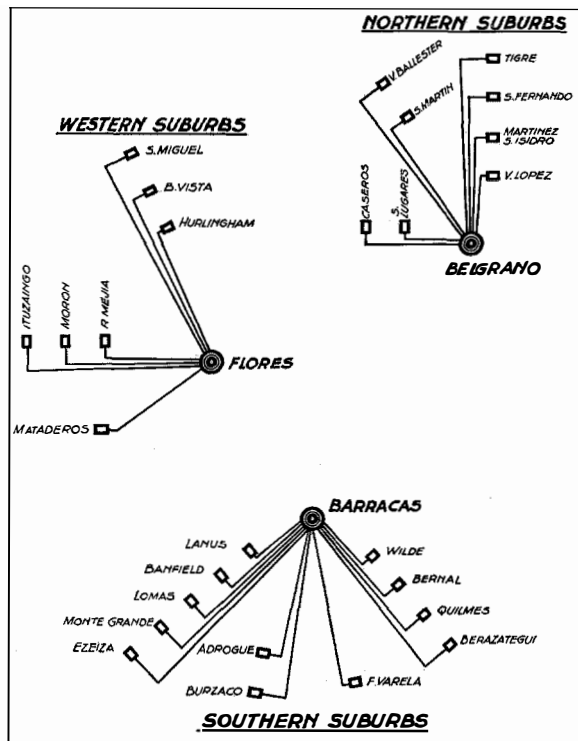

Figure 8—Concentration of Suburban Lines.

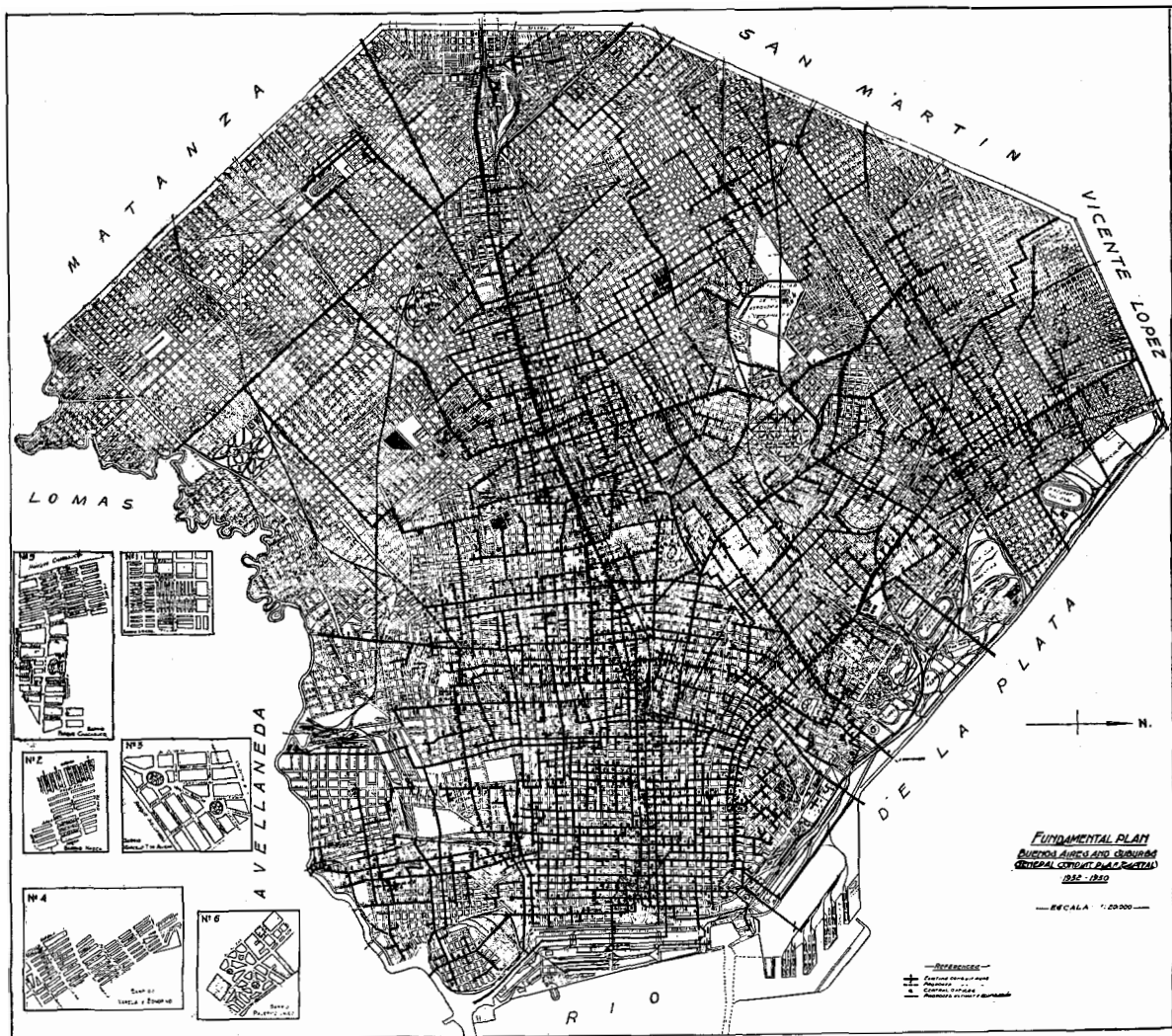

Figure 9—Fundamental Plan—Buenos Aires and Suburbs, General Conduit Plan (Capital) 1932-1950.

at Belgrano, Barracas and Flores; and for non-contiguous intersuburban traffic special tandem positions will be placed at the toll office, using the toll switching trunks for this local service. It is proposed to use a three-digit prefix to reach the suburban operator from the city offices, the first two digits of which will route the call to the outer tandem office and the third digit will extend the call to the required suburban office. Each Capital office will thus have a common group of trunks to each of the three tandem offices, and the common group of trunks from each tandem office to each suburban office of the zone will be available to all the city offices. The suburban "A" positions will be fitted with dials, and for outgoing traffic the

suburban operator will dial into selectors at the tandem office. If automatic be introduced in the suburbs at a later date, six digits will still suffice if the suburban office is limited to 1,000 lines. If a large automatic suburban office should have to be provided, this could be done for this particular office by introducing seven-digit numbers, three for the characteristic and four for the subscriber number, without affecting the six-digit system.

General Conduit Plan

Fig. 9 shows the general conduit plan of the Capital in 1950, existing ducts being included in full line and proposed extensions in dotted lines.

The ultimate locations of the central offices and their boundaries are also indicated. The conduit routes on this map have been laid out to provide direct feed to the central offices for all lines insofar as the topography of the office area and other conditions permit. The number of conduits in the larger runs have been calculated assuming 900 working pairs of 24-gauge per conduit, other gauges having been equated to this size; 1,800-pair, 26-gauge cable has been assumed in exceptional cases where the use of this cable is permissible from the transmission standpoint and would avoid increasing large duct runs. Nine hundred pair, 22-gauge cable at 80% efficiency is the maximum congestion calculated for trunk conduits. Three ducts have been allowed for toll purposes along the routes of the toll entrance cables to Morón and Adrogué. The figures for the quantity of proposed ducts shown on the plan represent a point on the curve of duct requirements for that particular section as of 1950.

The duct system of the Capital at present contains 576,000 metres of duct run and 1,940,000 duct metres, giving an average size of conduit slightly over 3-ways.

The extensions proposed up to 1950 total 83,000 metres and 390,000 duct metres. This extension appears small, but it must be borne in mind that a large portion of the ducts were planned when 600-pair cable was the maximum size; also, 340,000 duct metres of the existing total belong to the affiliated Compañía Telefónica Argentina and are spare for the most part at the present time. Mainly due to the availability of these conduits, virtually no increase of ducts will be required in the

downtown section over the study period.

Standard multiple-unit vitrified clay conduit of $3\frac{1}{4}$ inches square section is used throughout the system with but few exceptions; the largest size being 49-way along Defensa Street to the entrance of Avenida office. The backbone of the system runs up Rivadavia street, connecting Avenida, Mayo, Cuyo, Mitre, Caballito, Flores, Floresta and Liniers offices; as will be seen from the plan, other main routes run north, north-west and south. The northern route connects Juncal, Palermo, Belgrano, Nuñez and the northern suburbs; the north-west route connects Cuyo, Chacrita, Urquiza, Devoto and the north-west suburbs; and the southern route connects Buen Orden, Barracas, Avellaneda, and the southern suburbs.

Poles are prohibited in the downtown section of the Federal Capital, distribution being effected by means of roof distributing points with aerial cable and block wiring, the larger buildings being cabled internally. Standard aerial cable and pole construction is used in the outer part of the town, the absence of alleyways necessitating the use of public streets for these cables; and experimental use is also being made of jute-protected cable where growth is slow, although municipal regulations with regard to protection and depth of laying tend to annul the economies of this type of construction.

Owing to the reduced scale of the general conduit plan presented in Fig. 9, the aerial feeder routes are not indicated. Individual conduit plans have been prepared for each office area, both in the Capital and suburbs, showing full details of these routes.

The Practical Application of the New Unit of Circuit Performance

By J. COLLARD, Ph.D.

Introduction

IN a previous paper, "A New Criterion of Circuit Performance,"¹ a new unit was described for the rating of the overall performance of a telephone circuit, taking into account the various factors such as attenuation, noise and side-tone which affect transmission. That paper dealt with the theoretical aspects of the new unit and the method of building up the scale of performance. The present paper recapitulates briefly the important features of the new unit and its derivation, and then describes the application of the unit to practical problems.

The New Unit

The chief aim in the development of this new unit was to obtain a scale for the rating of telephone circuits without the use of complicated and arbitrary circuits of reference. Furthermore, by basing the unit on fundamental and scientific reasoning it has been possible to avoid the use of empirical methods with their inherent disadvantages.

The new scale is obtained by taking perfect performance and zero performance as the ends of the scale and then dividing the range in between into one hundred equal parts. A method of doing this would be to take a high quality circuit passing all frequencies from zero to infinity without distortion and to divide it up into ten separate circuits by means of band pass filters. Suppose that these ten circuits had the frequency ranges zero to F_1 , F_1 to F_2 , F_2 to F_3 , F_9 to infinity and let these frequencies be so chosen that each of these ten circuits gives the same performance. Then since each circuit has the same performance and all ten circuits together make up the high quality circuit, it follows that the performance of each single circuit is one-tenth that of the high quality circuit. But, by definition, the high

quality circuit, since it gives perfect performance, has a rating of 100 units. Hence, each of the ten circuits has a performance of 10 units. By putting together two or more of these circuits we could obviously obtain circuits having performances of 20, 30, 40 100 units and, by carrying the subdivision further, it would be possible to obtain a series of standard circuits having any desired performance. To obtain the rating of a given circuit it would only be necessary to find the standard circuit which gave the same performance as the given circuit, and the rating of this standard circuit would be the rating of the given circuit. The above procedure has been given merely to make clear the nature of the new scale and in actual practice a much more simple method is used.

Criterion of Performance

The procedure of choosing circuits so that they have the same performance naturally brings up the question as to what we are to take as the criterion of performance. In the previous paper the author discussed this question and showed that if sound articulation were taken as the criterion then the rating of the circuit in terms of the new unit was numerically equal to the ideal band articulation of the circuit. Band articulation is an important quantity since, just as speech is composed of a number of words and each word is composed of a number of speech sounds, so each speech sound is composed of a number of frequency components or bands which characterise the sound. The recognition of speech thus depends essentially on the recognition of the characteristic bands. Moreover, the various factors which affect telephone transmission, such as attenuation and noise, do so by virtue of the fact that they add to or modify the characteristic bands passing over the circuit.

Band articulation is thus the basic quantity and all other quantities such as sound articulation, logatome articulation, intelligibility and

¹ *Electrical Communication*, April, 1933.

repetition rate are merely derivatives. The band articulation is therefore the one quantity of fundamental importance in all questions relating to the transmission of speech. We shall therefore assume that two circuits have the same performance when they give the same value of sound articulation and consequently the rating of a circuit in terms of the new unit will be equal to the band articulation.

Since, with the above assumption, the rating of a circuit in terms of the new unit becomes equal to its band articulation we could, theoretically at any rate, measure the band articulation of the circuit directly by physical methods and thus obtain the rating. At the present moment, however, the technique of this measurement is still in the experimental stage and we have therefore to make use of the sound articulation for which a definite experimental technique exists and which is, as we have seen, a derivative of band articulation. The relation between sound articulation and band articulation has already been worked out by the author and forms the basis of the technique for calibrating articulation crews which was provisionally adopted by the C.C.I.F. This relation is given in the Proceedings of the Plenary Session of the C.C.I., June, 1930 (page 83, English edition; page 153, French edition). One step in this technique consists in the determination of the ideal band articulation of the circuit so that if the C.C.I. method is used to measure the articulation of a circuit, the rating of this circuit in terms of the new unit is automatically obtained.

Determination of Rating

The rating of a telephone circuit in terms of the new unit can be obtained either by direct measurement of the sound articulation or by calculation from the overall constants of the circuit. Below are given examples of these two methods.

(i) Measurement

As already pointed out the adoption of the C.C.I. technique for articulation testing gives directly the rating of the circuit in the new unit. In accordance with this technique the measured sound articulation is first converted into the corresponding band articulation. This value is then divided by the crew factor to eliminate the effect of crew training. The resulting value is the

ideal band articulation and is therefore the rating of the circuit in terms of the new unit.

As an illustration of this method, an example has been worked out in full. The rating was required for a circuit consisting of two subscribers' sets connected by loops of No. 22 gauge cable and repeating coil cord circuits to a distortionless trunk of 20 db. Articulation tests were made on this circuit using four receivers in series-parallel arrangement at the receiving end. Measurements were made on the following lengths of loop: 0, 2, 4, 6 and 8 kilometres.

| Loop Length (km.) | Measured Articulation | | Crew Factor | Ideal Band Articulation |
|-------------------|-----------------------|------|-------------|-------------------------|
| | Sound | Band | | |
| 0 | 95.2 | 74.4 | .875 | 85.0 |
| 2 | 95.2 | 74.4 | .885 | 84.0 |
| 4 | 93.6 | 68.6 | .885 | 77.5 |
| 6 | 93.0 | 66.6 | .885 | 75.5 |
| 8 | 89.6 | 56.7 | .880 | 64.5 |

The values in the last column are the ratings of the circuits in terms of the new unit of performance. The ratings of other circuits can, of course, be obtained in a similar way from the measured articulation results.

It should be noted that if the callers, in an articulation test, call with a standard calling intensity the results do not take into account the effect of the side tone on the talker's intensity prevailing during an ordinary conversation. This effect is taken into account by measuring the change in talking intensity produced by various amounts of side tone under actual conversational conditions and then either making a suitable adjustment of the caller's intensity during the articulation test or allowing for the change subsequently. Where the circuit conditions include room noise the effect of this on the caller's intensity is allowed for in the same way. The effect of room noise at the receiving end can, of course, be included in the measurement.

(ii) Calculation

There are often occasions, especially in the design and development of new apparatus and circuits, when it is required to know the effect on the performance of some change in the circuit before that change is actually put into practice. In such cases the use of the new unit makes it

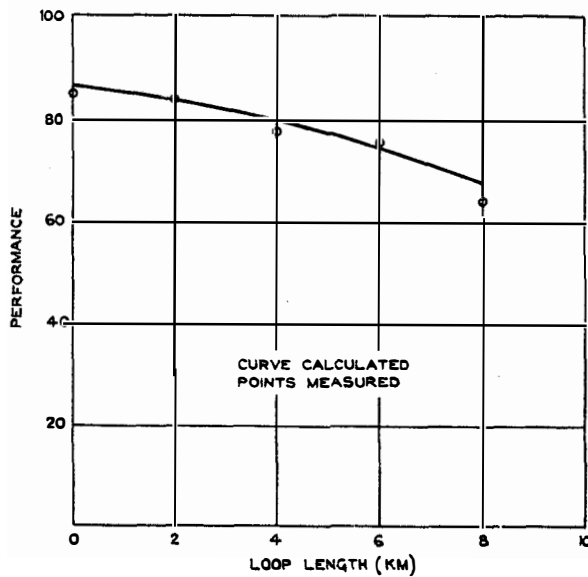

Figure 1

possible to predict the performance of a circuit in terms of the new unit from a knowledge of the overall attenuation-frequency characteristics of the circuit and other factors such as noises and side tone. This technique has already been described in the paper by the author published in the 1930 Proceedings of the C.C.I., page 153. Since the publication of the above paper considerable work has been done in the re-evaluation of the fundamental constants on which the calculation is based as well as in the comparison of measured and calculated results and, while work still remains to be done in this connection, the results so far obtained have been so satisfactory that there is no doubt that the performance of a circuit in terms of the new unit can be predicted from the circuit characteristics with considerable accuracy. It is hoped soon to publish the results of this further work; and as an example of the agreement between measured and calculated performance, the measured values given above have been plotted in Fig. 1 together with a curve calculated from the characteristics of the circuit. It will be seen that the curve passes very well through the measured points.

Practical Presentation

The previous section showed how circuits could be rated in terms of the new unit and the

object of this section is to discuss methods of presenting the rating values for use in practical problems. The particular form most suitable for this data depends, of course, to a certain extent on the use to which it is to be put. It is proposed, therefore, to deal with the matter in a general way and to indicate different methods of employing the new rating values. The actual values given in this paper are for illustration only and would, of course, require modification to suit particular cases.

The curves given in Figs. 2 and 3 show one way of presenting the information. Fig. 2 gives a family of curves which enable the performance to be obtained for a circuit consisting of two sets of subscriber's apparatus connected by No. 22 gauge loops of different lengths and repeating coil cord circuits to a trunk with variable attenuation and an effective transmission up to 3000 p:s. These curves give the performance of this circuit for the condition of no line noise and no room noise. The effect of line and room noise is taken into account by the set of curves of Fig. 3. In the paper dealing with the calculation of articulation referred to above, the author showed that, since the effect of noise was to raise the listener's threshold and so mask some of the characteristic speech bands, it could best be taken into account by treating it as an addition to the overall attenuation of the circuit. The curves of Fig. 3 give the resultant masking produced by different amounts of line noise and room noise when using the subscriber's apparatus for which the curves of Fig. 2 were constructed. The

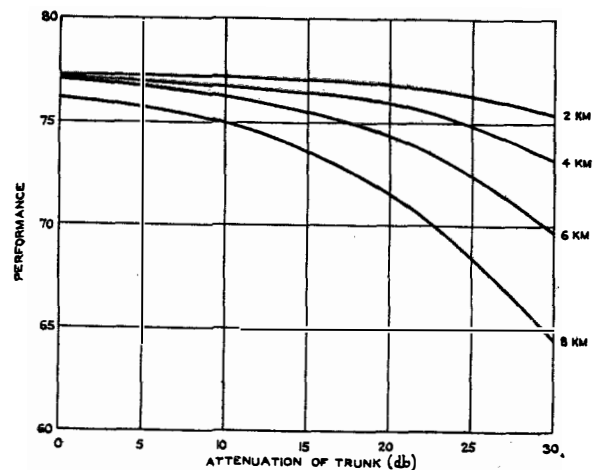

Figure 2

masking produced by noise will depend on the frequency and magnitude of the different components, and curves similar to those of Fig. 3 could, of course, be prepared for different types of noise. For general use, however, it is probably best to employ curves giving average results. Since the effect of room noise depends essentially on the amount of side tone present in the subscriber's apparatus in question, a different set of these masking curves would, of course, be obtained for different sets. The method of using these curves is to obtain the average masking for the particular combination of line and room noise in question and to add it to the attenuation of the trunk. Then, using this modified value of trunk attenuation and the given loop length, the resultant performance may be obtained from the curves of Fig. 2.

The curves of Fig. 2 can be modified to take into account the effect of side tone on the calling intensity in the way already described.

As an example of the use of these curves, suppose it is desired to determine the performance of a circuit having loops of 8 kilometres, a trunk of 20 db., line noise of 0.3 millivolts and room noise of 50 db. From the curves of Fig. 3 it will be seen that the masking is 2 db.; adding this to the trunk attenuation we get 22 db., and using this value and a loop length of 8 kilometres we find from Fig. 2 that the performance is 71 units. If the problem were to find what loop length gave a performance of 71 units with the conditions of the previous problem, a similar procedure would be followed.

These two sets of curves thus take into consideration the following factors:

- (a) Subscriber's set—from the points of view of both transmission and reception.
- (b) Cord circuit.
- (c) Loop.
- (d) Trunk.
- (e) Line noise.
- (f) Room noise.
- (g) Side tone.

Other factors which affect the performance of the circuit can, of course, be taken into account in a similar way.

The above curves take into account the frequency characteristics of the various parts of the circuit and if the frequency characteristic of

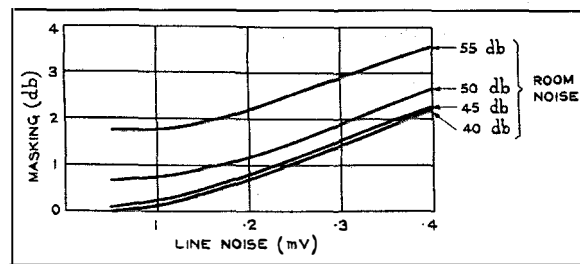

Figure 3

some part, such, for example, as the trunk, is changed, a new set of curves would be obtained. In some cases, however, where only an approximate result is required, it is possible to use the same set of curves and then add to the resultant performance an allowance to take the change into account. For example, the curves of Fig. 2 were obtained for a trunk where attenuation frequency characteristic was flat up to 3000 p:s after which it rose very rapidly so that no components above 3000 p:s were transmitted. Where the frequency characteristic can be said to have an effective cut-off of this nature, a performance allowance can be made for these values of cut-off frequency. The curve of Fig. 4 gives allowances for different cut-off frequencies.

In the same way allowances can in many cases be used for different gauges of loops. The curves of Fig. 2 were constructed for No. 22 gauge loops and the following table gives allowances for other gauges. In this case the allowances depend to a certain extent on the overall performance of the circuit but, since we are as a rule working to a definite limiting performance, they would be given for that value of performance. The curves for No. 22 gauge could therefore be used for these gauges, the appropriate allowances being added.

| Loop Gauge | Allowance for Performance of 65 |
|------------|---------------------------------|
| 19 | +2.5 |
| 22 | 0 |
| 24 | -3.5 |

Composite Circuits

Where we are concerned with telephone circuits which pass through different countries it

may happen that different parts of the circuits have different characteristics. For instance, one part of the circuit may have a cut-off of 2600 p:s while another part has a cut-off of 3000 p:s, or else the subscriber's apparatus in the two terminal countries may be different. Examples of this nature and methods of handling them are suggested below.

(a) *Cut-off Frequency*

Where one part of a circuit has a lower cut-off than the other parts it is clear that the circuit may be treated as though the lower cut-off operated over the whole circuit. If, therefore, we had a circuit with an equivalent of 10 db. and a cut-off of 260 p:s joined to a circuit having an equivalent of 15 db. and a cut-off of 3000 p:s we should treat the circuit as though it had an equivalent of 25 db. and a cut-off of 2600 p:s. Where the circuits cannot be considered as having a simple cut-off it will be necessary, of course, to add together the two attenuation-frequency curves and determine the rating for the combined curve.

(b) *Noise*

In a long circuit line, noise will enter the different sections of line and will be transmitted down the circuit to the ends. It will be obvious that the correct way of finding the total noise in this case is to reduce each individual noise by an amount corresponding to the amount of attenuation it will experience in being transmitted to the end. The resultant amounts of noise may then be added as the square root of the sum of the squares.

(c) *Subscriber's Apparatus*

The curves of Fig. 2 were prepared for a certain type of subscriber's apparatus, the same type being assumed at the two ends. In international calls the apparatus at the two ends may be different. In this case similar curves could be prepared for apparatus A talking to apparatus B and for apparatus B talking to apparatus A. However, in most cases it would probably be sufficient to work out the performance for the circuit using apparatus A and a similar value for the circuit using apparatus B and then take the mean of these two results.

Where in composite circuits of this nature any doubt exists as to the true performance, the

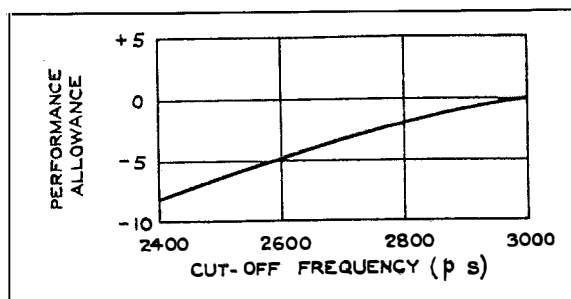

Figure 4

problem can always be solved by obtaining the overall characteristics of the circuit and working out the performance of the circuit.

General Discussion of the New Unit

The new unit was based on the use of articulation as the criterion of equality of circuit performance. Since an alternative proposal has been made for using the number of repetitions taking place during an ordinary telephone conversation as a criterion of the performance of the circuit, it may be of interest to discuss this question. Since the repetition rate is obtained under actual service conditions it is claimed that it takes into account the users' reaction to the circuit. However, there may be a question in some cases whether repetition rate really allows properly for the subscribers' reactions. Suppose that there are two identical circuits and let an articulation test be made over one and a repetition count over the other. A certain value of articulation and of repetition rate will be obtained. If, now, the attenuation of the two circuits is increased, the articulation, assuming that a constant calling volume be used, will fall. In the case of the other circuit, however, the listener will ask the talker to raise his voice and this will, to a certain extent, counteract the effect of the added attenuation thus giving quite a small number of repetitions.

Judging by the repetition rate, therefore, one would estimate that the increase in attenuation had had little effect on the performance. The subscribers, on the other hand, fatigued by the extra effort entailed in raising their voices, would consider the added attenuation to have very materially affected the performance. It would seem, therefore, that the repetition rate thus fails to take full account of this important

reaction of the subscribers and, in fact, the articulation measured at constant calling intensity, due to its relatively greater drop in value, may be a better criterion of the circuit and of the subscribers' reactions.

A further advantage of using articulation is the comparative ease with which it can be measured. The measurement of repetition rate on the other hand, is so laborious that only a relatively few number of combinations of circuits can be tested by its means and this necessitates the use of somewhat complicated and empirical methods to bridge over the gaps. This objection applies most strongly in the case of new circuits and apparatus since, as pointed out by McKown and Emling in a recent paper,² the technique for handling ratings based on repetition rates may not be applicable owing to its empirical nature.

Conclusion

In conclusion, it may be said that the new unit has the following advantages:

- (1) It is a logical unit developed from fundamental considerations of speech and hearing.

² "A System of Effective Transmission Data for Rating Telephone Circuits," by F. W. McKown and J. W. Emling, *The Bell System Technical Journal*, July, 1933.

- (2) It is easy to measure through the medium of articulation tests and there is reason to suppose that in the future it may be possible to determine ratings in terms of the new unit by direct objective measurements on circuits.

This ease of measurement, together with the fundamental nature of the unit, means that there is no need to use empirical methods for eking out the experimental data.

- (3) Through its identity with band articulation, which is the one fundamental quantity in connection with the transmission of speech, the new unit enables the rating of circuits to be calculated from the overall constants of the circuits. Hence the performance of new circuits can be predicted in advance.
- (4) The unit is independent of circuits of reference. The rating of a circuit in terms of some reference circuit which represents present day conditions suffers from the disadvantage that these ratings will become meaningless when changes in design make the reference circuit obsolete. Furthermore, different reference circuits would have to be used in different countries owing to different circuit conditions with a consequent possibility of confusion.
- (5) The measurement of the articulation of a circuit using the C.C.I. technique automatically gives the ratings of the circuit in terms of the new unit. Hence the ordinary routine articulation tests carried out by the "SFERT" laboratory, will provide valuable data in connection with the ratings of circuits in terms of the new unit.

Application of Type C and Type D Carrier Systems to Non-Standard Lines

By BRUCE H. McCURDY
Engineer of Toll Lines and Transmission

and J. H. HOLMES
Societatea Anonimă Română de Telefoane

EDITOR'S NOTE: *Because of space limitations, this paper is being published in two installments. The second portion will appear in the July, 1934 issue of Electrical Communication and will cover methods of measurement and prevention of crosstalk, results obtained, maintenance problems and general conclusions.*

I. Introduction

IN the April, 1932 issue of *Electrical Communication*¹ mention was made of the extensive application of carrier in the development of the Rumanian toll network. That such a concentration of carrier systems may become the rule rather than the exception is strongly indicated by the data presented by Mr. Jammer,² and the authors have felt that a summary of the problems which are to be met with and a discussion of the general methods of solutions adopted in Rumania would be of interest to telephone engineers.

The operation of a number of systems over parallel circuits of uniform characteristics is not a new accomplishment and may be said to be a relatively simple engineering problem, provided one knows at the beginning the maximum number of channels which are likely to be used over all toll leads and provided the existing open-wire circuits have been designed to take care of this condition. The "Standard" carrier systems with their use of so-called "normal" and "staggered" frequencies allow the operation of at least two three-channel systems over the same lead with a comparatively small amount of transposing. They use a comparatively low frequency range and since crosstalk is a function of frequency, the lower frequency range reduces the amount of work necessary on the outside plant considerably.

These systems are of the carrier suppression

type, transmitting only one side-band and supplying the carrier by independent means at the receiving end. The variation in circuit equivalent for variation in line attenuation with weather changes is, therefore, just half what it would be if the carrier for demodulation was not supplied locally from an entirely independent source. This will be apparent when it is considered that the voice output is proportional to the product of carrier and side-band and if both are varied by changes in line attenuation, the change will be just double what it would be if only one of these components varied. Suppressed carrier operation, therefore, makes for a maximum of stability.

Pilot channels enable the energy levels to be kept properly distributed, and the proper overall equivalents to be maintained without having to remove the circuits from service for lining up during the day, thus reducing lost circuit time and simplifying circuit maintenance.

The above features were all found to be of considerable value in applying carrier to the existing Rumanian plant.

Where the so-called "American" type of pole line construction with its ten-pin crossarms is used and the circuits are transposed especially for carrier use, the number of separate systems can be made equal to the number of physical circuits available.³ One of the greatest fields for the use of carrier, in any case, is in bridging the gap between the time when an existing open-wire line is fully loaded (assuming no use of carrier) and

¹ "Toll Plant Engineering," by Bruce H. McCurdy.

² "Carrier Current Systems Form Important Part of World Communication Network"—*Electrical Communication*, October, 1932.

³ See paper by H. A. Affel, C. S. Demarest and C. W. Green, "Carrier Systems on Long Distance Telephone Lines," June, 1928, read before the American Institute of Electrical Engineers.

the time when toll cable can be proved in over this route, the object being to eliminate the need of building new open-wire leads which in a few years more would have to give way to cable. Under prevailing economic conditions this possibility of using carrier is being exploited to the utmost in the endeavor to extend the period of life of all existing pole lines.

The lines with which the carrier engineer will have to deal, however, frequently will be found to be far from uniform in type of construction and spacing of circuits, with consequent difficulty in obtaining sufficient separation between systems, while the cutting in of a large number of intermediate transpositions, because of existing methods of mounting circuits and non-uniformity of pole spacings, will often present serious problems involving practical construction and expense considerations. If we add to these difficulties the complication of the almost inevitable modifications in circuit requirements which

always result from unanticipated changes in business and from changes in the general toll program brought about by other unforeseen influences, it will be appreciated that carrier engineering as viewed by the local operating unit is far from being the simple problem outlined in the handbooks, but is rather one requiring a true engineering analysis based on the fundamental technical factors involved. The development of the Rumanian toll network has provided an excellent opportunity for practical experience in applying to actual practice the theory of carrier circuit engineering and the results obtained are considered sufficiently interesting to warrant summarising them for the benefit of others interested in the same problem.

The carrier system layout for Rumania as a whole is, in its present form, far from ideal and it is not the object of this paper to recommend that similar layouts be employed in other countries. A glance at Fig. 1, which indicates the

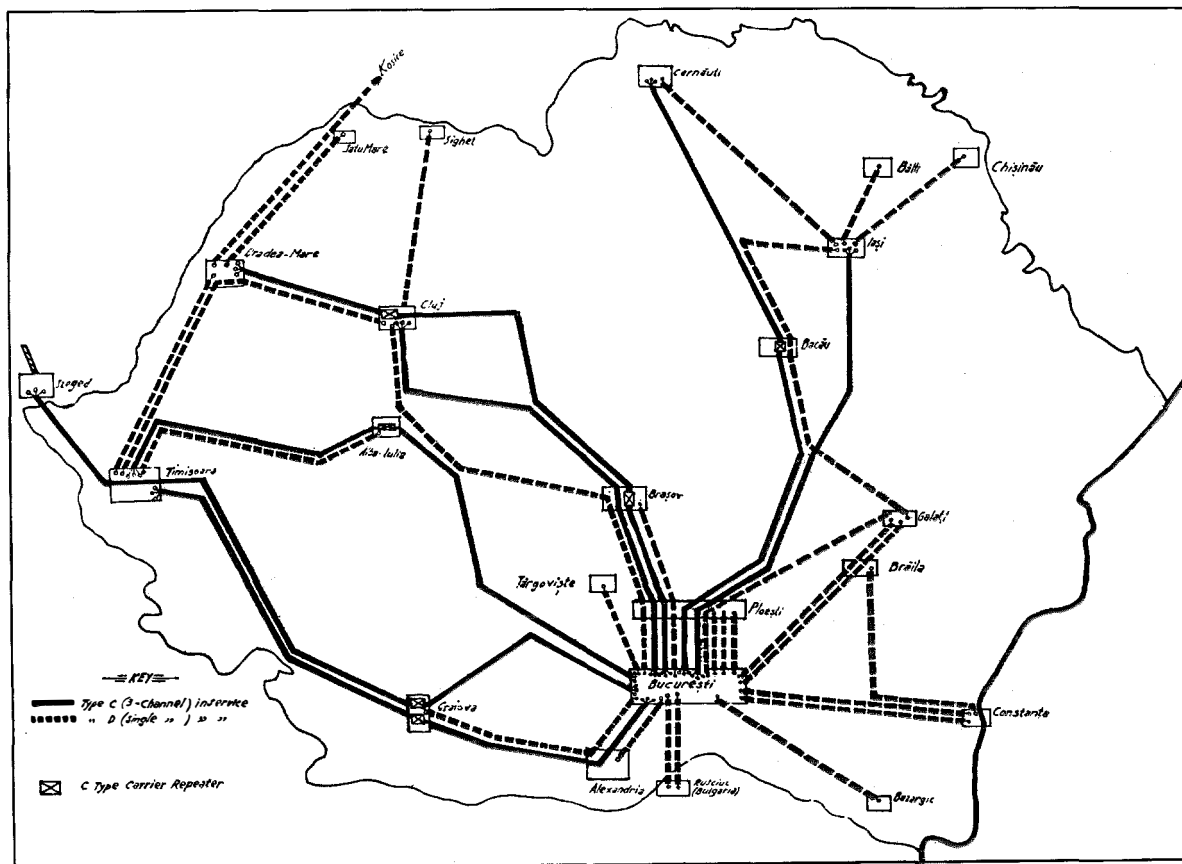

Figure 1—Rumanian Carrier Systems—1933.

existing carrier layout in Rumania, will disclose numerous cases which any carrier engineer will red-pencil immediately as being not only undesirable but in all probability directly productive of a deteriorated grade of facilities. Actually, as a result of the extreme flexibility of the "Standard" carrier systems in meeting extraordinary conditions, every one of the systems shown in Fig. 1 is operating and providing a satisfactory grade of service. It has required, however, a very large amount of detailed investigation and engineering to achieve this result.

At the time the International Telephone and Telegraph Corporation took over the operation of the Rumanian telephone system through its subsidiary operating company, the Societatea Anonimă Română de Telefoane, no adequate estimate of future toll requirements could be made. The one very apparent feature of the system was a large unsatisfied demand for toll service. The immediate problem, therefore, was one of providing a very considerable number of additional high-grade long-haul toll circuits as economically as possible, and in a way that would not commit the company to any major reconstruction program until the most economical toll plant construction program could be determined. Three type C carrier systems were ordered for immediate installation over three of the main routes: Bucarest-Timișoara via Craiova; Bucarest-Oradea via Brașov and Cluj; and Bucarest-Cernauți via Bacău. These systems were in the nature of stop-gaps to care temporarily for known demands for increased facilities. Very little information was available as to how the Rumanian lines, which were for the most part of bronze rather than copper and supported on porcelain rather than glass insulators, would behave under varying conditions of weather, and for this reason the standard handbook rules were applied with a large factor of safety to care for any abnormal conditions which might arise.

In the meantime all available data were gathered regarding condition of lines and circuits, probable traffic requirements by years, etc., and a general Toll Fundamental Plan prepared. Toward the end of the first year of operation a number of factors had entered into the picture which tended toward a maximum possible use of carrier. In the first place it was found that

accurate traffic forecasts over a period of years could not be made on the basis of available data with sufficient exactitude to allow precise engineering of major toll plant additions on a large scale, especially those involving toll cables. Where additional facilities had been provided by the three carrier systems mentioned or where the range of calling had been extended by increasing the grade of service over existing circuits, an increase in traffic was in every case immediately obtained. The probable trend of such increases beyond a period of one or two years was, however, highly problematical, especially in view of the general economic conditions prevailing throughout the world.

In the second place a detailed inspection of toll leads had indicated that a large portion of the main leads throughout the country, although too heavily loaded to allow the addition of any large amount of copper, were in relatively good condition. The replacement of such leads by either cable or new open-wire pole leads would not be economical unless it could be proved definitely that the increased maintenance of such old leads as compared with new construction would overbalance the carrying charges on the new plant. Such data as could be gathered tended to show that these leads should be maintained as long as possible rather than be replaced. The need for immediate additions in a large number of circuit groups within the next year or two was, however, very apparent.

Taking such factors into account, the most practical solution appeared to be to use carrier to the fullest limit on these existing lines. The economies involved in such a use of carrier rather than copper circuits, even in the cases where the latter could be hung without any large amount of pole work, were well demonstrable while the extreme flexibility of and high salvage on such systems when possible changes in ultimate use are considered, make this solution still more advantageous.

A further reason for the use of carrier circuits arose when the question of possible overall equivalents was considered; for, coincident with the problem of adding new circuits, there had arisen the problems of extending the range of the possible toll-center-to-toll-center connections which could be put up. A study had just been

completed showing that even with the three systems already in service, providing as they did nine additional low-equivalent, high grade circuits between important centers, less than 30% of the toll-center-to-toll-center connections within the country were within commercial limits of transmission. It had already been discovered in connection with the setting up of certain of the international circuits over the original three carrier systems that there was a very appreciable transmission margin available in the majority of the channels: i.e., they could be worked at considerably less than the 6 db. equivalent when they formed part of a through connection. This inherent gain, if it could be utilised, would provide an excellent means of reducing the overall equivalent on many switched connections, and the carrier engineers were called upon to investigate this possibility.

The general carrier study, therefore, necessitated the simultaneous answering of the following questions:

- (a) What systems can be added to the Rumanian network assuming no addition to the present copper and no changes in open-wire arrangement other than the cutting in of transpositions?
- (b) Assuming repeater and terminal stations as they existed at the end of 1931 or as called for by the Toll Fundamental Plan, what are the lowest equivalents that can be obtained on the various carrier channels used for switching business within the country?
- (c) What bearing will the reduction in overall losses on the various systems have on the answer to question (a) above and what are the best overall working equivalents obtainable where the maximum number of systems contemplated is in service?

It will readily be appreciated that such an investigation involved more than the application of ordinary handbook rules since the two factors which are usually reciprocally subject to control by the carrier systems engineer, i.e., repeater spacings and gauge of wire, were fixed in advance and fixed in decidedly non-standard and non-uniform ways. The analysis, therefore, had to go back to the fundamental electrical theory and be worked out from this standpoint, though a certain amount of "cut-and-try" was resorted to. A limited number of routes were still available over which additional facilities were required and over which the carrier systems could be used with no question as to the resulting circuits satisfactorily meeting all requirements. It was

perfectly safe, therefore, to order and install certain of the systems over questionable routes for experimental purposes since, if the preliminary calculations were not borne out in actual practice, such systems could be transferred at little or no expense to the routes over which there was no question. Actually this has not been necessary since means have been found in every case to make the systems work as originally laid out; and as a result of the experiments carried out with these systems, the carrier engineer has been provided with sufficient data to allow him, as the number of alternate routes available was diminished, to calculate from the high-frequency characteristics of the lines (factors measurable in advance) the exact voice-frequency performance of the various proposed channels and thus to determine exactly where carrier could or could not be used. The following sections summarise the experience gained and the conclusions arrived at in Rumania.

II. Technical Considerations Involved in Layout of Parallel Systems

The theoretical background of carrier telephony and the specific points which must be investigated in dealing with the normal cases are familiar to most telephone engineers and it is not the purpose of this article to go into any long theoretical discussion of general carrier systems theory. The important consideration from the operating engineer's viewpoint is the predetermination of the voice-frequency characteristics from the measurable carrier-frequency characteristics of the lines which it is proposed to use.

The local operating engineer in laying out a carrier network involving parallel systems will find himself dealing with data which may conveniently be grouped roughly into three main groups:

- (a) The voice-frequency transmission performance requirements established for the voice-frequency circuits which the carrier systems provide: minimum net working equivalent, allowable noise at the circuit terminals and allowable crosstalk.
- (b) The performance characteristics of the terminal equipment (modulators, demodulators with their accompanying amplifiers, if any) and the repeaters.
- (c) The carrier-frequency characteristics of the lines to be used as a base for the various systems, including the inter-circuit interference at carrier-frequencies.

The first of these, i.e., the system transmission

performance requirements are usually fixed in advance by the Toll Fundamental Plan or Transmission Performance Requirements of the organization and, for the normal case, may be said to be beyond the control of the carrier engineer and are to be regarded rather as the objectives toward which he must work. Actually in the case of Rumania, where the toll network is still in a transition stage, considerable modifications of the temporary standards were made as a result of certain of the carrier investigations, as well as some modification in the performance requirements towards which the systems were being engineered. Such changes were, however, merely of a temporary nature and in working toward the final or permanent plant layout the limits which will be given in the following systems were strictly adhered to.

The second group of factors, i.e., the performance requirements of the equipment, may also be said to be out of the control of the carrier

engineer except insofar as the variations in gain made possible by the various adjustments provided are made use of by him. The real work of the carrier engineer is, therefore, the investigation and control of the carrier-frequency phenomena which take place between the output terminals of the equipment at one end and the input terminals at the other, and their interpretation in terms of overall voice-frequency performance in connection with the voice-frequency terminals at each end, making use of the known characteristics of the equipment and engineering towards the transmission performance requirements in force in the local system.

Voice-Frequency Transmission Performance Requirements of the Carrier Systems Used in the Rumanian Toll Network

As a matter of interest it may be well to list the voice-frequency transmission performance requirements to which the ultimate toll plant as

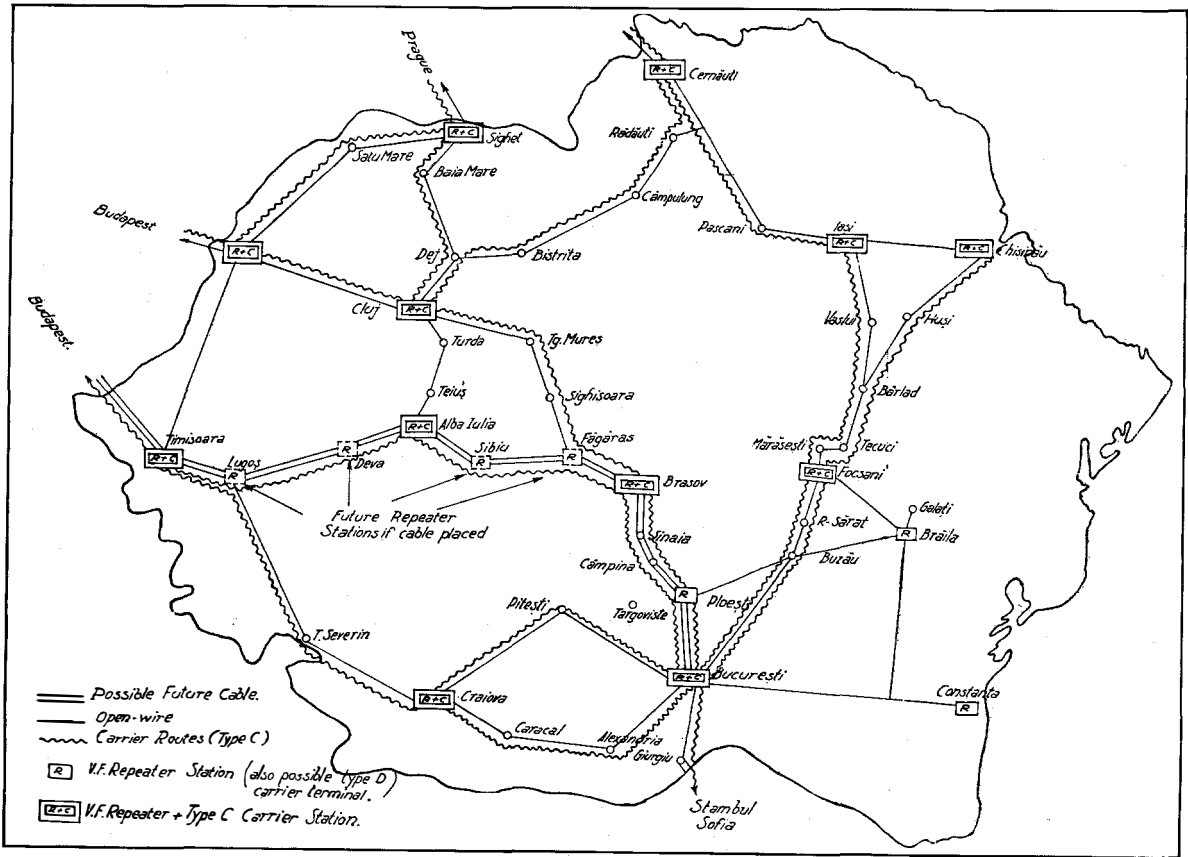

Figure 2—Future Repeater and Carrier Layout for Rumania.

foreseen in the Toll Fundamental Plan for Rumania is to be engineered. They are as follows:

- (1) *Attenuation:* Four main divisions of main internal toll circuits are foreseen with minimum working equivalents as given below:

| | Minimum Net Working Equivalent | Operating Equivalent on Terminal Calls |
|---|--------------------------------|--|
| Toll End Links Bucarest . . | 3 db. | 6 db. |
| Inter-Area Circuits. | 6 db. | 6 db. |
| Secondary Toll Circuits. . . | 7 db. | 7 db. |
| Special Terminal Grade Toll Circuits. | 12-15 db. | 12-15 db. |

International circuits will be engineered in accordance with the C. C. I. recommendations which at present call for a circuit of roughly 7 db. between international switching points.

- (2) *Noise:* The maximum noise allowable on any circuit in the ultimate network is 200 units. Any increase in noise over this figure will have to be taken into consideration as a transmission impairment and the usual penalties applied when calculating the transmission performance rating of the circuit.
- (3) *Crosstalk:* The maximum allowable voice-frequency crosstalk between any two principal open-wire or carrier circuits in the ultimate toll network is 1500 units. As will be seen later, this value applies only in the case of actual intelligible crosstalk and not to distorted crosstalk.

On the basis of the above standards, carrier engineers in connection with the Toll Fundamental Plan had established for the overall toll network the most satisfactory location of carrier repeater and terminal points to meet the above limits with the circuit arrangement as at present foreseen. The arrangement is shown in Fig. 2 and was determined in accordance with the standard rules normally used in the laying out of carrier systems assuming, of course, standard open-wire facilities especially designed to cater for this use of carrier. No variation from standard limits for carrier was assumed for this final layout since those limits give the best layout for the permanent condition when both performance requirements and maintenance are considered.

Insofar as possible these same transmission performance standards were assumed (except for the variations in transmission equivalent already mentioned) in the case of the temporary network. The only tolerance definitely allowed was in the matter of noise where a value of 400 N.U.

was accepted as satisfactory for the transition period.

With these factors as a starting point the carrier engineers began to study the question of added circuit facilities to care for the urgent demands of the traffic which was, day by day, increasing in volume.

III. Method of Investigating Possibilities of Adding Carrier Systems to the Rumanian Network

The general method followed in analysing the possibilities of adding carrier systems to the Rumanian network was to take each case individually, investigating it from the standpoint of the particular system which it was proposed to use and laying out each system to meet to the best advantage the transmission standards set, disregarding for the time being the other parallel systems. Then with such a layout assumed, the inter-system relationships and the practical methods, if any, of overcoming the interference which would result were investigated. The first part of the problem, therefore, involved nothing

TABLE I.
Minimum Permissible Level Below Receiving Toll Test Board Level

| No. of Repeater Sections | 200 Noise Units | | 400 Noise Units | |
|--------------------------|-------------------------------|--------|-----------------|--------|
| | 14 KC | 26 KC | 14 KC | 26 KC |
| | (a) Carrier Transposed Lines | | | |
| 1 | 17.5 db. | 19 db. | 23.5 db. | 25 db. |
| 2 | 14.5 | 16 | 20.5 | 22 |
| 4 | 11.5 | 13 | 17.5 | 19 |
| 8 | 8.5 | 10 | 14.5 | 16 |
| | (b) Ordinary Transposed Lines | | | |
| 1 | 5 db. | 16 db. | 11 db. | 22 db. |
| 2 | 2 | 13 | 8 | 19 |
| 4 | -1 | 10 | 5 | 16 |
| 8 | -4 | 7 | 2 | 13 |

NOTE: The above values refer to 5 mm. copper circuits. For 4 mm. these minimum values may be decreased by 1 db. and for 3 mm. by 2 db.

more than normal measurement of attenuation on the lines available and the calculation of the level diagrams for the various systems, a procedure which is familiar to most transmission engineers. The upper levels allowable in the case of the various systems available to obviate distortion are set by the manufacturer while the lower levels to keep "normal" noise within the 200 or the 400 unit noise limit are known. (See Table 1). There were, of course, certain practical difficulties which had to be investigated, such as,—

- (a) *The elimination of short sections of iron wire, bad joints or cable.* In almost every long line it was found that at various times before this company took over the toll network incidental replacements on copper circuits had been made with iron wire. It was found also that the old twisted joints had in many places corroded so as to cause high losses. Where these faults had definitely interfered with the voice-frequency operation of the circuits they had been eliminated. Where the reaction on such voice-frequency operation was not serious—this applied more especially to the presence of iron in the circuit—these faults had not always been cleared, and before proceeding further with the carrier investigation a general clean-up of the lines was necessary. Cable was eliminated only where it definitely interfered with the proposed operation of carrier.
- (b) *Absorption.* A few instances were found where the attenuation frequency curve showed a very marked peak within a narrow frequency band due to resonance, usually with a parallel telephone circuit against which the line in question was not transposed. Simple transpositions at frequent intervals in all cases resulted in the elimination of such effects. It is interesting to note that since the completion of the general transposition program for the elimination of voice-frequency noise and crosstalk, practically no cases of this phenomenon have been encountered.

With such basic data available the engineers started to consider the question of interference which is the real problem to be discussed in this paper. The final toll program, as laid out by the Toll Lines and Transmission Department to meet the 1932 traffic requirements most economically, called for a total of three type C three-channel systems, three D.A.1 single channel systems and sixteen D. 1 single channel systems to be added to the plant in that year. The original program called for approximately half of these circuits to be supplied by open-wire in order to obtain an even spread year-by-year between carrier and wire work. Changes in

economic conditions, however, eventually forced the employment of carrier for all of these circuits, and further complicated the problem inasmuch as certain of the carrier systems engineered on the basis of the first program were in process of installation prior to the time the change in procedure was decided on. In all but two of the single-channel systems parallelisms over a portion or the whole of the route would be involved. The major cases of parallels were as follows:

- (a) *Bucarest-Timişoara-Szeged:* The growth of the systems over the two main routes between Bucarest and Timişoara may be taken as illustrating very well the way in which the problem of operating like systems over parallel routes was forced upon the carrier engineers. A second three-channel system was required between Bucarest and Timişoara as well as one between Bucarest and Szeged, the end of the European cable system just across the Hungarian frontier. The original layout called for a type C.N.3 system to Szeged via the Braşov and Alba Julia route (a normal system being specified since, between Bucarest and Braşov, it would parallel the existing C.S.3 system to Oradea) and a C.N.3 system to Timişoara via Craiova to parallel the existing C.S.3 Timişoara system. Ultimate changes in program forced the use of type D systems between Bucarest and Braşov on all available facilities and the rerouting of the first portion of the Bucarest-Alba Julia-Timişoara system to a new route via Piteşti to Sibiu and Alba Julia. Later it was found necessary to route a type D system over the same route as the Bucarest-Alba Julia-Timişoara system. Final tests indicated better operating conditions with the Szeged system via Alba Julia interchanged with the Timişoara system originally routed via Craiova. The final parallels which, therefore, had to be investigated are illustrated in Fig. 3.
- (b) *Bucarest-Ploeşti:* The final layout called for a total over this 63 km. run of six D. 1 systems, one D.A.1 system, two C.S.3 systems and one C.N.3 system. The wires in this section are carried on four ten-pin crossarms and there were available a total of nineteen circuits of various gauges from 5 mm. to 2 mm.
- (c) *Ploeşti-Braşov:* In addition to the existing one C.S.3 and one D.1 systems it was desired to add two D.1 and one D.A.1 systems. The difficulty here lay in the fact that since only six circuits existed over the last half of this run and since these six were carried on four-pin supports, there was practically no possibility of segregation.
- (d) *Other miscellaneous parallels* (See Fig. 1).

IV. The Inter-System Interference Problem

(a) Transmission Survey of Network

In 1932, as soon as it was realized that the use of carrier was being stressed in the manner

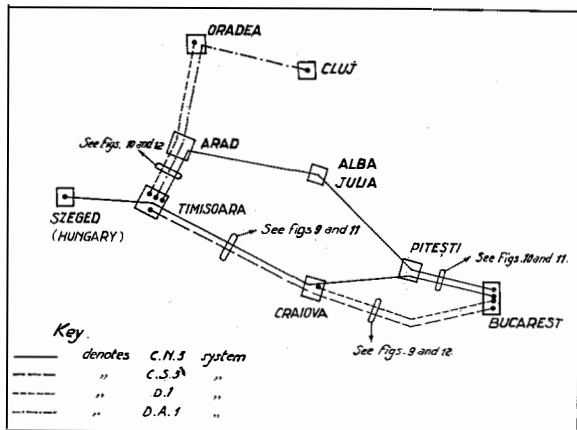

Figure 3—Application of Type C and Type D Carrier Systems.

already described, it was decided to make a complete survey of the crosstalk conditions at carrier-frequency in order first of all to ascertain whether there were any faults, irregularities, absorption points or other phenomena requiring combative measures and, secondly, in order to collect sufficient data to enable the voice-frequency crosstalk at the terminals to be estimated from a knowledge of the levels at which the systems are worked.

This survey was started in the early summer and lasted with intervals for about five months, during which time about three thousand readings of various quantities were taken and recorded, these being afterwards corrected for attenuation, level, etc., so as to give an approximate indication of the V. F. crosstalk at the terminals.

(b) Prediction of V. F. Crosstalk

A general method of calculating the V. F. crosstalk from the H. F. characteristics of the lines involved has been in general use for some time, but, inasmuch as the Rumanian carrier network offered a ready means of further verifying the theory and testing its accuracy, the authors determined to make a very complete series of tests and, by working these out and checking them against actual performance, to obtain accurate data as to their practical application in the engineering of extensive carrier networks. The theory is roughly as follows:

Considering the case of two similar systems, i.e., two systems transmitting frequency bands of the same width in the same range, there will be a certain crosstalk at carrier frequencies be-

tween the lines of these two systems due to parallelism. This line crosstalk is, just as in the case of V. F. circuits, of two kinds, near-end and far-end.

(c) Near-End Crosstalk

A little consideration will indicate that in the majority of cases near-end crosstalk is unimportant in carrier systems. Referring to Fig. 4, which shows the frequency allocations of the Standard Types "C" and "D" carrier systems, it will be seen that the "D" systems transmit in the A-B direction the frequency band 7600-10,100 p.s. Considering two systems, X and Y, system X transmits the above band from the A terminal, and this band, due to line crosstalk, enters the line of system Y and returns as near-end crosstalk to the A terminal of system Y. The A terminal of system Y is, however, non-receptive to this band, since the band width of the demodulator band filter at the A terminal covers only the range 4170-6670 p.s; therefore, the near-end crosstalk is not perceptible.

(d) Far-End Crosstalk

Far-end crosstalk, however, can easily occur, since the B terminal of system Y, being receptive to a band-width similar to that of system X in the A-B direction, demodulates the interference and produces intelligible crosstalk.

In the case of dissimilar systems, this far-end crosstalk can, of course, also occur except that in this case the interference will be unintelligible due to the mutual displacement of the disturbing and disturbed frequency bands and, in some cases, to the fact that the interfering bands are

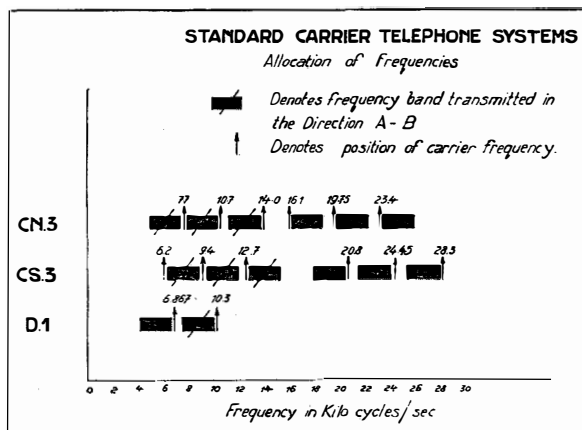

Figure 4—Standard Carrier Telephone Systems—Allocation of Frequencies.

oppositely situated with reference to their respective carrier frequencies.

Now, although near-end line crosstalk is not in itself perceptible as such, it is important that it be kept low, since a high crosstalk of this nature can by reflection produce an appreciable increase in far-end crosstalk. Since, however, a high near-end crosstalk is almost always accompanied by high far-end values, it was considered satisfactory for the purposes of the Rumanian survey to concentrate attention almost entirely on the far-end crosstalk and only a few near-end crosstalk-frequency determinations were made, these being found satisfactory in all cases.

If now the far-end crosstalk between two circuits be measured at suitable frequency intervals over the range 7600-10100 p.s. corresponding to the "D" system frequency band in the A-B direction, a series of values will be obtained which will give an average crosstalk over the band.

(e) Calculation of V. F. Crosstalk

The method of arriving from this value at the V. F. crosstalk at the terminals by calculation follows directly from the definition of far-end crosstalk, which may be stated as follows:

"The far-end crosstalk between two circuits X and Y is the difference in level, expressed in decibels,⁴ between the disturbing current at the input to the disturbing circuit and the crosstalk current received at the far-end of the disturbed circuit."

This definition applies equally either to the whole or to part of the circuit, so that in the case where the carrier-frequency crosstalk is measured on the line alone the result, when corrected in the manner described below, gives the difference in level between the carrier-frequency disturbing input at one end of one line and the disturbed output at the other end of the other line.

A brief description of the apparatus used for measuring crosstalk is given in Section V. It will be sufficient here to say that the measured values of far-end crosstalk give directly the difference in level between disturbed and disturbing circuits at the receiving end; hence, in order to arrive at the crosstalk as required by the definition, it is necessary to add to the measured

⁴ For convenience, all values are given in this paper in decibels (db.), rather than in crosstalk units, since the crosstalk measuring set is calibrated in db.

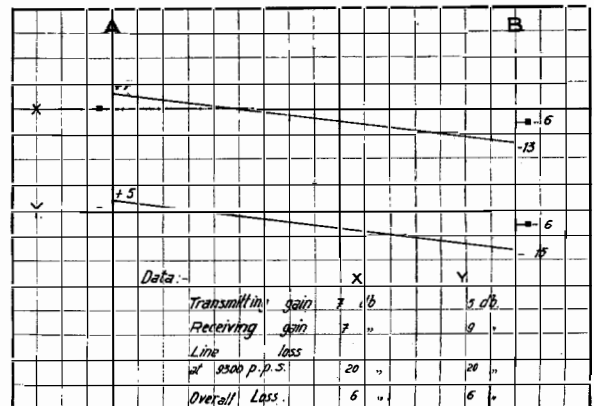

Figure 5—Hypothetical Level Diagrams for "D" Systems X and Y, Direction A-B.

values the loss between the terminals of the disturbing circuit.

Referring now to Fig. 5 which shows hypothetical level diagrams for two "D" systems, X and Y, between terminals A and B, let us suppose that the average corrected line crosstalk at carrier-frequencies in the range 7600-10100 p.s. corresponding to the A-B direction of transmission, is 75 db. from line X into line Y. Then, for far-end crosstalk from system X into system Y in the direction A-B, the equivalent along the crosstalk path = transmitting gain of A terminal, system X - corrected carrier line crosstalk + receiving gain of B terminal, system Y = $7 - 75 + 9 = -59$ db., that is to say, the crosstalk is 59 db.

Supposing now that the line crosstalk from line Y into line X is 77 db. then for the V. F. crosstalk at terminal B from system Y into system X we have

$$\text{V. F. Crosstalk} = 5 - 77 + 7 = -65 \text{ db.}$$

(f) Mean Band Crosstalk

The method of calculating the mean value of band crosstalk from the carrier-frequency values was to take the crosstalk values at the quarter-points and weight them according to their importance, weighting the crosstalk at the center point with 0.7, and the other two values with 0.15 each, and then add them.⁵ This procedure gives a value which makes some allowance for the rising attenuation due to the band filters at the extremities of the frequency band as well as

⁵ For purposes of weighting and adding, it is of course necessary to express all values in crosstalk units.

for the fact that the crosstalk in the centre of the band is in any case more disturbing.

(g) *Factors Controlling V. F. Crosstalk*

It is seen from the simple example given above that the V. F. crosstalk produced by carrier-frequency (C. F.) interference depends both on the magnitude of this interference and on the levels at which the systems are worked. In the example given, it is assumed that the systems are required to work at an overall loss of 6 db. and that the transmitting gain of one is 7 db. and of the other 5 db., both of which values fall within the limits at present in force. In the case of the system with the transmitting gain of only 5 db., the receiving gain at the other end has to be correspondingly higher in order to give the 6 db. overall loss required. Although the variations between the two systems are small, these all occur in such a direction as to make a difference of 6 db. in the V. F. crosstalk which, if expressed in crosstalk units, would mean that when system X is interfering, the crosstalk is twice what it would be if system Y were disturbing.

(h) *Methods of Crosstalk Reduction*

It is thus at once apparent that much may be done to reduce the possibility of interference between parallel systems and in fact several cases of high crosstalk in the Rumanian carrier system were eliminated merely by level readjustment. In all cases of high crosstalk, therefore, attention should be paid both to the magnitude of the carrier-frequency crosstalk, which is a function of the line alone, and to the relative levels of the two mutually interfering systems.

The carrier-frequency crosstalk may be reduced in two ways, i.e., (a) by transposing the circuits against each other at suitable intervals and (b) by segregating the circuits on the poles.

The choice between these two methods will, of course, depend on circumstances. For ex-

ample, in cases where very few circuits exist on the route, segregation may be almost impossible, and transposition will be resorted to. On a heavy pole lead, however, if there are only a few carrier systems, it will usually be found possible to segregate these satisfactorily. If there are many carrier systems, however, a combination of segregation and transposition will be necessary. In segregation in such cases special attention will be paid to the separation as far as possible of

(i) Systems which transmit similar frequency bands.

(ii) Systems which of necessity operate at very different transmission levels along their common route, e.g., a "C" system and a "D.1" system.

In cases where a "staggered" system is to be worked over a lead where a "normal" system is in operation or vice-versa, it will often be found that by keeping the level differences between the two systems small, they can both be made to operate satisfactorily without much attention being paid to segregation or transpositions, and often such systems have been put into service without any preliminary crosstalk preventive measures, these being taken later where found necessary.

With regard to the reduction of crosstalk by level correction, the objective, in general, should be, to ensure that the paralleling systems work in each direction at approximately the same levels. Occasionally it will be found that the corrected carrier-frequency far-end crosstalk between two lines is greater when one is disturbing than when the other is disturbing, even if the lines are in other respects similar. In such a case an attempt should be made to equalise the V. F. crosstalk by making the levels purposely different on the two lines, so that the one which creates more disturbance works at a correspondingly lower level than the other.

(To be continued in the July issue.)

New Final Selector Facilities for Step-by-Step Systems

By E. P. G. WRIGHT, A.M.I.E.E.

Standard Telephones and Cables, Limited

THE most recent developments in the design of final selector circuits are likely to prove attractive both to the traffic engineer and to the maintenance staff. The new features may be summarised as follows:

1. A P.B.X. hunting control arrangement in which the lines of any P.B.X. group need not be consecutive and can be intermingled with other P.B.X. groups.
2. Simplicity in providing various classes of line discrimination signals, e.g., changed numbers, dead numbers, etc.
3. The use of a skeleton multiple permitting a 200 outlet final selector group to provide service for 200 subscribers numbered over a 400 numbering range.

These facilities introduce definite advantages:

1. The ability to maintain a large proportion of the existing numbers at the time of transfer from manual operation.
2. The ability to use a higher proportion of the multiple numbers as working lines.
3. The ability to extend P.B.X. groups without number change and without the expense of an abnormal proportion of spare lines initially.
4. Simplicity in providing various classes of line discrimination signals.
5. The elimination of main frame, number unobtainable, tone equipments or dead number circuits.

The new circuit makes use of the controlled single motion switch principle and is illustrated in the accompanying schematic. Although this circuit has been primarily designed for the Bypass System, it could be incorporated with very little modification in other Step-by-Step systems. The final selector S has access to 200 lines which may contain up to 50 separate P.B.X. groups. Any remaining lines, after provision has been made for the 50 P.B.X. groups, can be used as individual single lines. The P.B.X. lines serving each subscriber need not be adjacent in number and the numbers may be intermingled over the 200 numbering range without restriction. Nevertheless, it is preferable for the P.B.X. numbers to be adjacent when possible, from the point of view of hunting time and switch wear. It is possible to arrange the num-

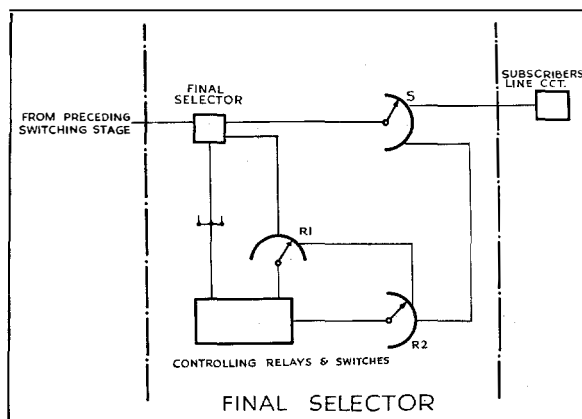

bers in the final selector multiple in the main frame order, so that small P.B.X. groups having two lines, terminating for example in 60 and 61, may be adjacent. When the last line of a P.B.X. group is reached, the final selector ceases to hunt, busy tone being connected to the caller.

The control terminals associated with all dead numbers are strapped together on a terminal strip, and if one of these numbers is dialled the caller receives a suitable tone from the final selector over a circuit, not including the wipers, because the final selector switch is not driven to the line in these circumstances. The line terminal and wires corresponding to the dead number can be used as an auxiliary P.B.X. line.

In the same way, all changed numbers have their control terminals strapped together, and if one of these numbers is dialled the caller is extended to an operator or a suitable tone is connected. The number of circuits to the operator can be varied to suit the traffic. In normal circumstances, one circuit may serve as many as twelve changed numbers. When desirable for traffic reasons, more than one line can be provided to the operator. For example, if a P.B.X. group with a large number of lines transfers to some other exchange on account of removal, it is to be anticipated that for a time there will be a large volume of changed number traffic from

this source. In these circumstances, certain of the lines previously forming part of the P.B.X. group would be transferred to increase the number of lines to the operator, and for a time the changed number operator lines would be a P.B.X. group. This arrangement also provides additional lines for P.B.X. extension purposes. These auxiliary lines are normally unnumbered because they can be reached only by dialling the number of the first P.B.X. line, which appears in the directory. Such lines would in consequence not normally be given night service facilities but, where it is particularly desired, suitable numbers would be allotted in the same or other groups and the lines connected together. In this way, the incoming traffic would search over all the P.B.X. lines forming the group.

It is a frequent practice to cease to allocate new subscribers to an old manual exchange, so that when the time comes for conversion there are possibly no more than 4,000 working lines spread over the 10,000 numbers. In order to avoid the provision of a large excess in final selector numbers or the wholesale changing of numbers at the time of conversion, a small modification to the new circuit offers a ready solution. The control switches are given access to four separate hundreds, whereas the final selectors and the final selector multiple are laid out in groups of 200 working numbers. The pairs of hundreds grouped together need not be consecutive.

To assist the traffic engineers, facilities are provided for connecting message registers temporarily with any line so that a record can be made of the number of attempts to connect to this particular line and to record also the number of

attempts in finding the line or group of lines engaged.

The principles of operation are as follows:

The hundreds digit discrimination is stored on a relay. The tens digit is stored on the switch R1, which causes the switch R2 to move to a secondary position depending on the tens digit. The units digit is received direct on the switch R2, which in consequence is set in a numerical position. The control contact of the line is tested through the switch R2 and in the case of a dead number, a suitable tone is connected without moving the switch S. In the case of a changed number, the switch S is driven round to an operator circuit or, alternatively, a suitable tone is connected without driving the switch. For an individual line, switch S is driven over a 100 wire marking multiple, the condition of the line being tested over the S switch wiper. For P.B.X. lines, a special control relay is operated when the S switch has been driven to the 1st line. If the 1st line is engaged, the R2 switch is advanced to a subsequent position over the same 100 line multiple. In its new position, R2 controls the further movement of the switch S searching for subsequent lines.

The operation for P.B.X. night lines is identical to that described for individual lines. The P.B.X. grouping and class distinction strapping is carried out on four terminal strips provided for each 200 line group.

In many countries where it is not the practice to use a line I.D.F., the number of subscribers calling equipments is equal to the final selector multiple and, in such cases, it is obvious that the arrangements described result in an additional saving in first cost.

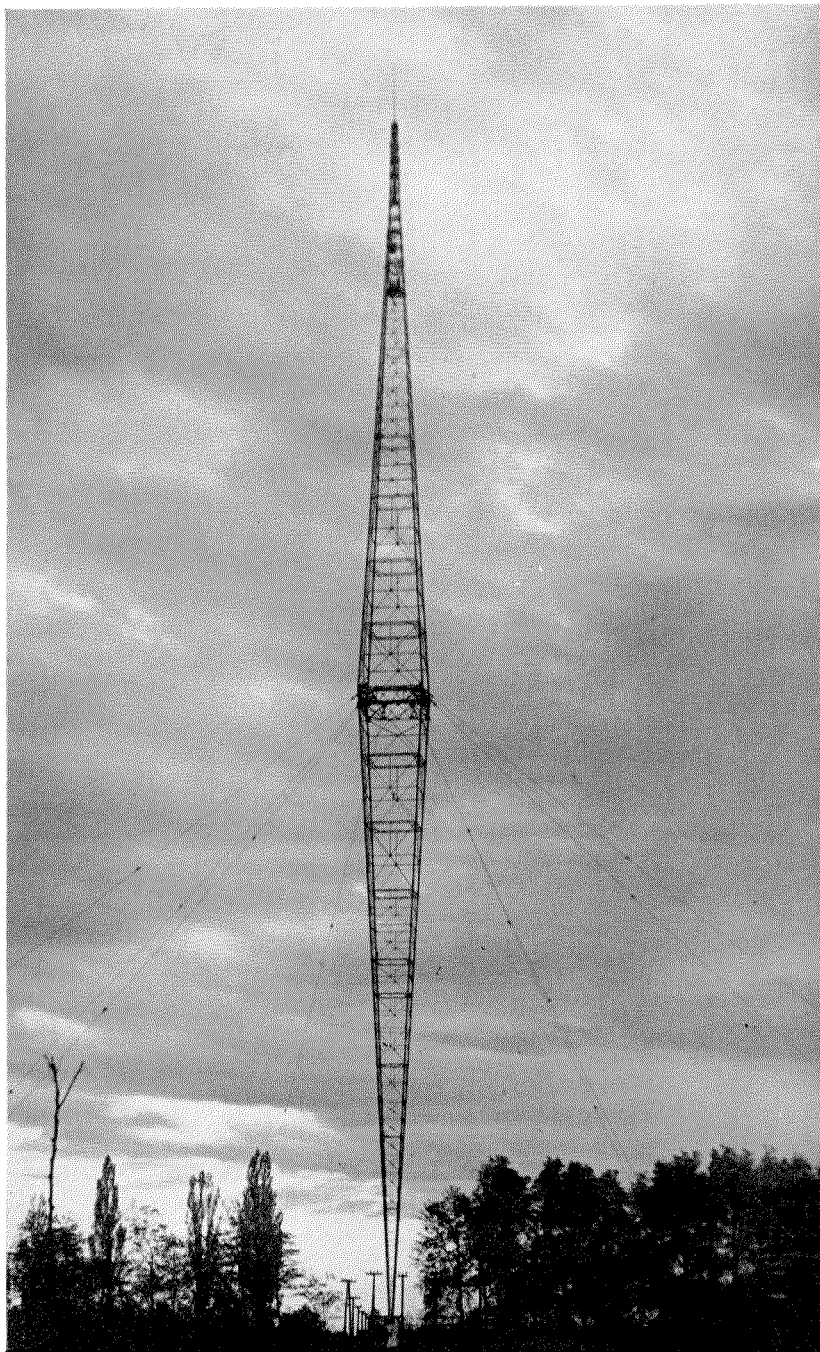

*Figure 1—Anti-Fading Antenna at Lakihegy near Budapest.
Overall Height—307 m. (1005 ft.).*

The Budapest Anti-Fading Antenna

By F. HOLLAND

Blaw-Knox Company, Limited

C. E. STRONG and F. C. McLEAN

Central Laboratories

THE most important factor limiting the area over which a single broadcasting transmitter can establish a perfectly reliable service is at present the phenomenon of fading. The quality of reception is frequently impaired by fading at distances less than those at which a modern high power transmitter can establish the minimum signal strength required for excellent service. Fading is, therefore, a serious obstacle in the way of the utilisation to the best advantage of the limited number of wavelengths available for broadcasting services.

Fading is due to interference at the receiving point between the directly propagated wave and high angle waves which are reflected down again from ionised layers situated some distance above the surface of the earth. Improvements in antenna design directed to increasing the ratio of the horizontally propagated field to the high angle field offer the best means of mitigating the effect. One way of meeting this requirement to a very considerable extent is the use of a vertical antenna of such height that the natural wavelength is between two and three times the wavelength on which the antenna is to be operated. This means the use of structures of much greater height, compared to the working wavelength, than has been usual in the past, and a new technique in antenna construction becomes necessary if the advantages are to be realised on the longer wavelengths in the medium wave broadcasting band.

The conventional system, consisting of an antenna suspended between two steel towers, can no longer be satisfactorily employed even if the towers are insulated at the base, on account of reactions which arise from currents introduced in the towers causing distortion of the distribution of field strength in the horizontal plane and giving rise, under certain conditions, to an increase in the unwanted high angle radiation. The solution arrived at lies in the use of a single

steel mast of special form, acting as the radiator (Fig. 1).

The longest wavelength for which an antenna of this type has so far been constructed is 549.5 metres, and the honour for the undertaking goes to Hungary. The antenna operates in conjunction with the new "Standard" 120 kW. transmitter at Lakihegy near Budapest. The mast is higher than the Eiffel Tower and is, therefore, the highest structure in Europe and the tallest mast in the world. It was constructed by the Hungarian State Steel Works to designs prepared by the Blaw-Knox Company, Limited, in co-operation with the Bell Telephone Laboratories, Inc.

The following is a general survey of the theory of operation, of the chief mechanical features, and of the observed results.

It has been shown by Ballantyne and others that for a given power fed into a vertical antenna the horizontal field increases with the height, up to a certain definite value, after which it decreases with further increase of height. The maximum occurs when the ratio of the working wavelength to the fundamental wavelength $\frac{\lambda}{\lambda_0} = .39$. As the fundamental wavelength of a vertical radiator is approximately 4.4 times the height, it follows that the antenna height for maximum horizontal field is about .58 of the working wavelength. Thus for the Budapest station working on 549.5 metres, a mast 318 metres high would have the optimum figure of merit. The height actually chosen is slightly less than this, namely, 307 metres, for reasons which will appear later.

The relative increase of horizontal field with mast height expressed in terms of the ratio of the working wavelength to the fundamental wavelength, $\frac{\lambda}{\lambda_0}$, is indicated in Fig. 2, which shows radiation diagrams in the vertical plane assuming perfectly conducting earth.

The high angle field, it will be observed, decreases with mast height until the antenna is half a wavelength long, that is, $\frac{\lambda}{\lambda_0} = .5$. Increasing the height further, a secondary loop of high angle radiation occurs. Fig. 3 shows more precisely the variation of the horizontal and high angle fields with height of the antenna expressed in terms of the ratio of the working wavelength to the fundamental wavelength of the structure, calculated for an assumed antenna loss resistance of 10 ohms and for perfect ground reflection. It will be observed from the upper curve that the horizontal field reaches a maximum when $\frac{\lambda}{\lambda_0} = .39$, and then the field at a distance of one kilometre from the antenna for an input power of one kilowatt is 410 millivolts per metre. This field is 3.4 db. above the field established by a quarter-wave antenna and 1.75 db. above the field from an antenna having $\frac{\lambda}{\lambda_0} = .6$ which is representative of the normal high T antenna employed in many

stations. To put these results in another way, a 100 kilowatt transmitter with an antenna of the optimum height, sets up the same useful field as a 150 kilowatt transmitter with a high T antenna of $\frac{\lambda}{\lambda_0} = .6$ or as a 218 kilowatt transmitter working with a quarter-wave antenna.

In addition to the considerable gain in useful field obtained by a high vertical radiator there is a very valuable reduction in the unwanted high angle radiation, as will be seen from the lower curve. The high angle fields fall off as the height is increased up to values of $\frac{\lambda}{\lambda_0}$ between .38 and .45, after which they begin to increase again owing to the appearance of the secondary loop referred to before. Taking the height of the Heaviside layer as 100 kilometres, the radiation in the directions for which the curves are drawn, namely 35 and 50 degrees to the vertical, would arrive back at the surface of the earth at distances of respectively 140 and 238 kilometres from the transmitter and would cause severe fading at such distances in zones where the reception would otherwise be good in the case of a medium wave high power transmitter working over average ground.

From the point of view of fading, a question arises as to whether it is advisable to increase the height beyond the half-wave point of view of the secondary loop of high angle radiation. It can be deduced, however, from curves such as those of Fig. 4, that for antennae working on comparatively long wavelengths, e.g., 400 to 500 metres, with good ground conditions, the increase in horizontal field makes up for the increased high angle field, and we find that the condition for minimum fading at the edge of the normal service area is close to the condition for maximum horizontal field. Actually, for a transmitter working on 550 metres, a ratio of working wavelength to fundamental wavelength between .42 and .44 would be a good compromise.

The effect of the high antenna on fading within the normal service area is illustrated more clearly by the curves of Fig. 5. The curves on the left represent the case of a quarter-wave antenna and those on the right, the case of an antenna of the optimum height. The curves sloping downwards from left to right show the useful field strength

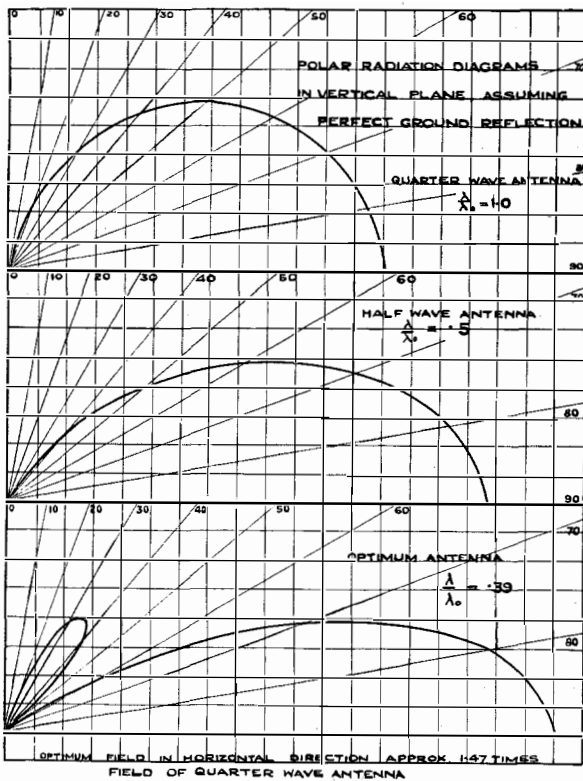

Figure 2—Field Strength Distribution Diagrams.

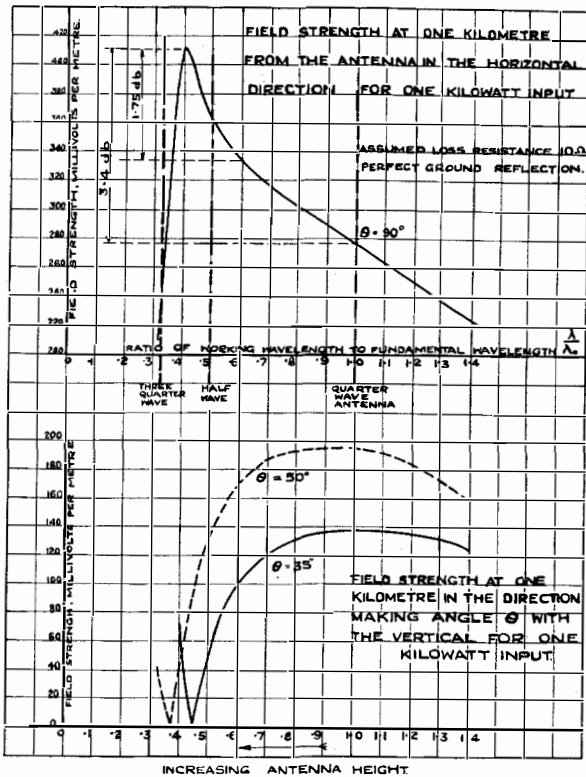

Figure 3—Horizontal and Inclined Radiation from Antenna

at different distances for one kilowatt input to the antenna, duly corrected for attenuation on the basis of a ground conductivity of 10^{-13} electromagnetic units. The curve on the right shows higher fields than that on the left, corresponding to the better figure of merit of the higher antenna. The other curves give the values at which reflected fields arrive back at ground level, assuming 100% reflection at an ionised layer 100 km. up.

If we assume that reception will be noticeably impaired by fading if the reflected field at the receiving point exceeds one-fifth of the directly propagated field, it appears from the curves that the expected limit of the zone of excellent reception would be at 120 kilometres from the transmitter for the case of a quarter-wave antenna, but would be pushed out to about 210 kilometres for the case of a high antenna having a ratio of working wavelength to fundamental wavelength equal to .42.

The value of $\frac{\lambda}{\lambda_0}$ finally chosen for the Buda-

pest antenna was .435. The working wavelength λ being 549.5, the height of the structure had to be adjusted so that the natural wavelength λ_0 should be 1266 metres. This fundamental wavelength was obtained for a tower height of 307 metres.

The peculiar form of mast construction illustrated in the first figure represents an excellent solution to the mechanical problems imposed by the special electrical requirements. The mast must be completely insulated and it is necessary, in order that correct current distribution should be obtained, that the capacity from the base to ground should be as low as possible.

The guy cables are attached at one section only, near the middle of the mast. This point corresponds very nearly to the voltage node, and the voltage applied to the guys is therefore very small, so that the question of guy insulation is simplified. The base insulator (Fig. 6) is comparatively small in volume and hence not liable to internal overheating under the applied radio frequency voltage.

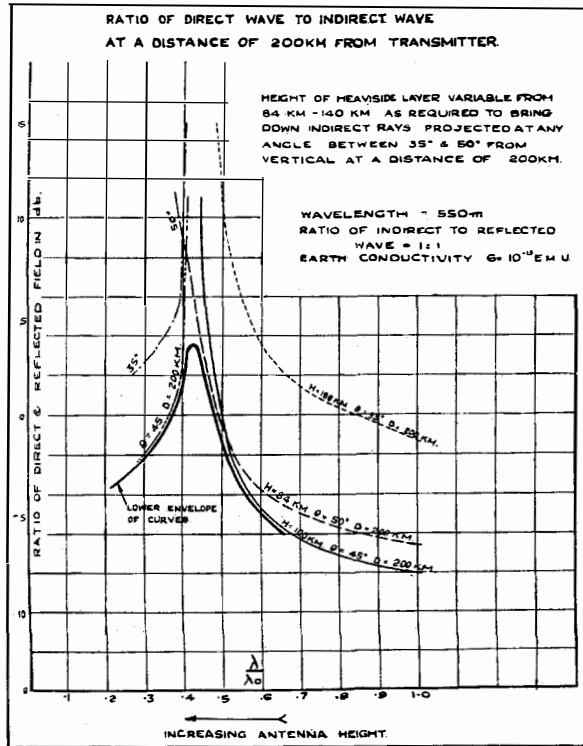

Figure 4—Variation of Ratio of Direct and Reflected Fields with Antenna Height.

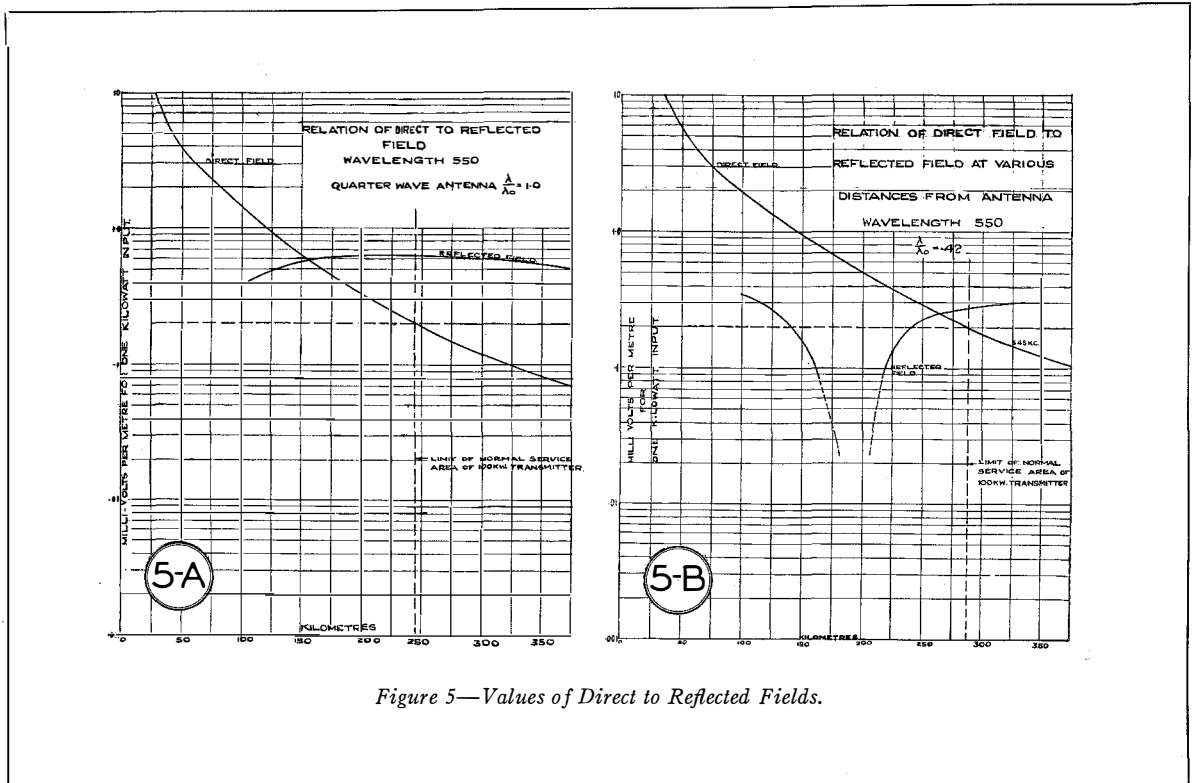

Figure 5—Values of Direct to Reflected Fields.

The mast is square in section and copper cables are carried from top to bottom at each corner on the outside of the structure to ensure good high frequency conductivity. Additional cables are provided at the centre sections where the current has the highest intensity.

The height of the structure can be varied by 12% from 285 to 315 metres by raising or lowering a galvanised steel pole projecting from the top, thus providing for possible error in forecasting the natural wavelength.

The base insulator is in the form of two cones meshed together at their narrower sections by a ball and socket connection in steel castings, permitting the antenna to pivot freely at this point.

The insulator has a total height of 1.5 metres. Its largest and smallest diameters are 90 cm. and 45 cm., respectively. It was proof tested to a compressive load of approximately 1,500,000 lbs.

The cross section of the tower increases uniformly from top and bottom towards the centre where eight guys are connected, two at each corner. The centre section is a square of 14.6 metres side.

Owing to the considerable width at the section

at which the guys are attached, the tendency for the tower to rotate about the centre in the case of unequal wind loads on the upper and lower halves, is taken up by strains in the guys rather than by a large shear resistance at the base.

The steel work was designed to have an adequate factor of safety for two conditions of loading:

- (1) Wind load applied to the portion above the guys only. This condition allows for a wind pressure of 30 lbs. per square foot acting on $1\frac{1}{2}$ times the projected area of steel in one face.
- (2) Wind load applied over the total length of the structure. This provides for a graduated wind pressure from 25 lbs. per square foot at the bottom of the structure, increasing uniformly to 51 lbs. per square foot at the top of the structure, acting on $1\frac{1}{2}$ times the projected area of the steel in one face.

The structure was so designed that when the maximum load on any member, based on either of these conditions, was increased 50%, no member was stressed above the elastic limit of the steel in the case of tension members, or the crippling strength in the case of compression members.

The guys are of $2\frac{1}{4}$ inches diameter wire rope

specially prestretched to eliminate the elongation that usually occurs some months after the first tensioning, and to ensure a constant modulus of elasticity. In the prestretching process each guy rope was subjected to a stress of 170 tons. In the structure the guy wires have a maximum initial tension of 34 tons and in service the maximum stress will not exceed 150 tons. Each guy wire is divided into four lengths. At the connection to the radiator itself, two guy insulators are inserted, the other separate lengths being divided by one guy insulator, making a total of five insulators per guy. The anchor points for the eight guy wires are spaced equally round a circle of 180 metres radius. The guys are at an angle of 40° to the horizontal. Each guy insulator when completely assembled was subjected to a proof tensile test of 170 tons. The insulators are so

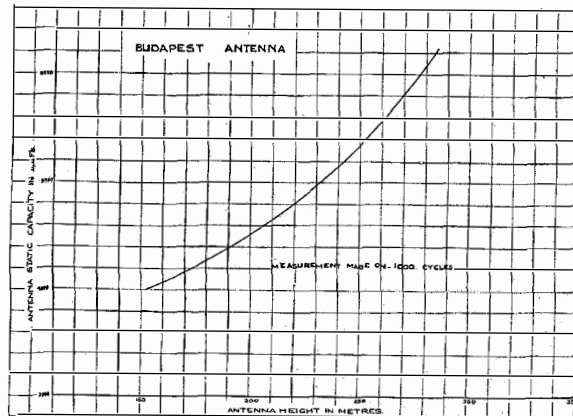

Figure 7—Antenna Capacity.

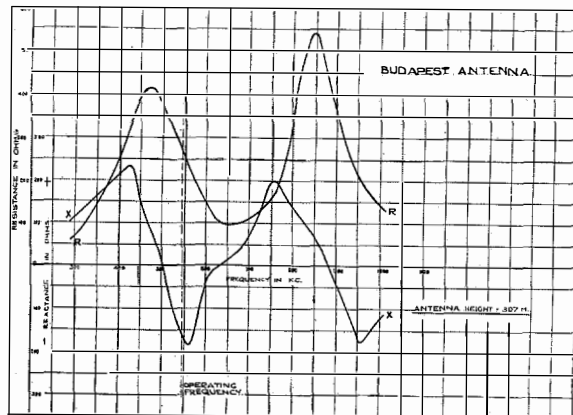

Figure 8—Antenna Impedance—Frequency Characteristic.

constructed as to eliminate tension in the porcelain.

The foundations comprise one centre foundation block and eight guy anchorages. The position of the guy anchorages in relation to the centre block required very accurate setting, as it was imperative that all the guys should have the same initial tension. The centre block was designed exclusively for compression, while the guy anchorages were designed for tension and sheer. The foundations are of reinforced concrete construction.

For warning to aircraft, six red lamps are installed on the tower, two at the top, two one-quarter way down and two half-way down the tower. The lamps are supplied with alternating current fed through high frequency choke coils and cables passing through the tubing of the antenna loading coil to a transformer mounted in the base of the tower.

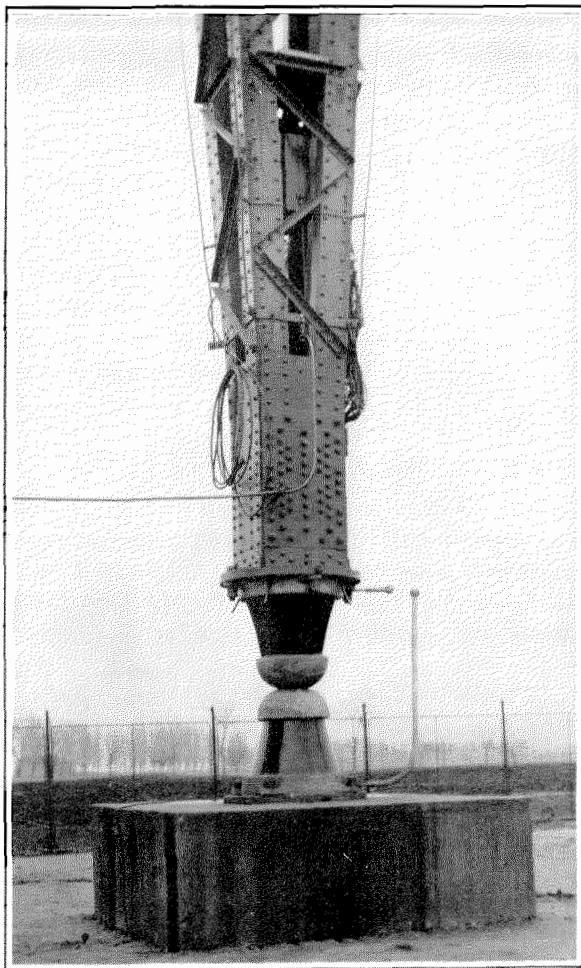

Figure 6—Base of Tower Showing Base Insulator.

The adjustable pole at the top of the tower terminates in a large sphere to avoid corona effects due to the high radio frequency voltage at that point.

The theory requires very low resistance in the ground below the antenna and an extensive earth system was, therefore, installed. It consists of radial wires buried 50 cm. deep in the ground going out to a distance of 180 metres from the tower. The wires are terminated near the base of the tower in a circular bus bar. The site on which the antenna is erected is ideal from the standpoint of the performance of the antenna, as the earth resistivity is exceptionally low.

The foundations were laid and the tower constructed in a period of twenty-seven weeks. Work on the foundations was started on the 28th April, 1933, and was completed on the 27th May. The erection of the structure itself commenced on the 6th July and the antenna was ready for testing on the 4th November.

During construction, measurements were made periodically of the impedance of the structure and curves were made showing the variation of impedance with height. These measurements could be made only after the height had passed 140 metres when the temporary uninsulated guys were removed after the installation of the final guys. The measurements included observations of the static capacity of the mast and of the resistance and reactance of the antenna between the base of the tower and ground on wavelengths from 300 to 1000 metres. The latter measurements were made by means of a high frequency impedance bridge.

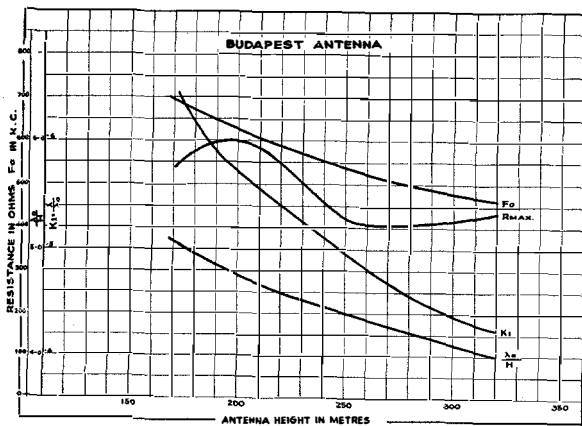

Figure 9—Antenna Characteristics—Height Curve.

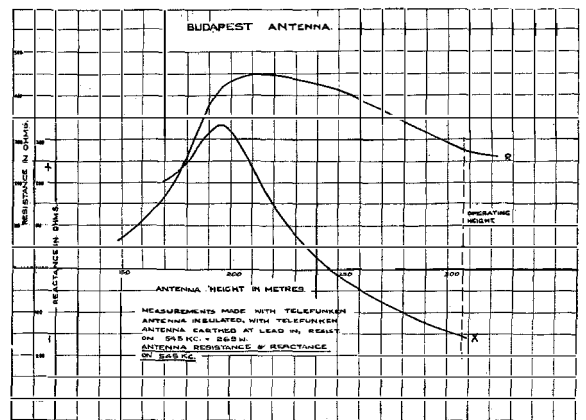

Figure 10—Antenna Impedance on the Operating Frequency.

Fig. 7 shows capacity plotted against height, and Fig. 8 is a typical curve showing the resistance and reactance plotted against frequency for a certain tower height. A series of such curves were made for various tower heights. From these curves, the natural wavelengths for different heights are determined by noting the frequency which corresponds to the half-wave operation of the antenna as indicated by the points of maximum resistance. It is observed that the zero reactance points do not correspond exactly to the points of maximum resistance. This effect is due partly to a slight inaccuracy in the measuring bridge, and partly to the effect of the capacity of the antenna base insulator. From these results the curves of Fig. 9 were drawn showing natural

wavelength and the ratio $\frac{\lambda}{\lambda_0}$ plotted against height. As the construction proceeded, watch was kept that the curves converged towards the required values for the height forecasted, and finally on the basis of the results the adjustable pole was set to the height required to give a ratio of $\frac{\lambda}{\lambda_0}$ equal to .435.

The curve of Fig. 10 shows the antenna impedance at various heights for the operating frequency of 545 kc. From this curve it will be seen that the tuning of the antenna is not sharp and that there will be no appreciable side-band cut-off due to the sharpness of resonance in the antenna.

It is evident also from Fig. 10 that although we should lose the special advantages of the antenna, it could, if necessary, be fed on any

frequency below 545 kc. since there is no point at which the antenna impedance is so high or the resonance curve so sharp that difficulties in feeding would be experienced. The antenna would not be suitable for frequencies higher than 545 kc. on account of the increased loop of high angle radiation.

With a power of 120 kW. delivered to the antenna, two series of field strength measurements were made. The first of these was with the antenna of the old station disconnected and the second with the old antenna grounded. The two series were necessary because it was found that the old antenna, which was also tuned to 545 metres, although at a distance of 750 metres, affected slightly the field strength diagram of the new antenna.

The field strength measurements were made with a Standard Field Strength Measuring Set at a number of points spaced more or less equally at

a distance of about 5 km. from the antenna. Some check measurements were also made with a loop antenna and thermocouple; the results agreed closely with those of the Field Strength Measuring Set. The measured field strengths were multiplied by the distance from the antenna and corrected for attenuation by the Sommerfeld formula, taking an earth conductivity of $\gamma = 10^{-13}$ electromagnetic units as determined from previous field strength measurements. The values of the corrected field multiplied by distance are shown in Fig. 11. From this diagram it is seen that the average ED product with the old antenna insulated is 4280. This corresponds to an antenna Figure of Merit of 391, expressed as the field in millivolts per metre at a distance of one kilometre for an input of one kilowatt. With the old antenna earthed, absorption in this antenna was reduced, resulting in an improvement in the ED product to 4641 and giving a Figure of

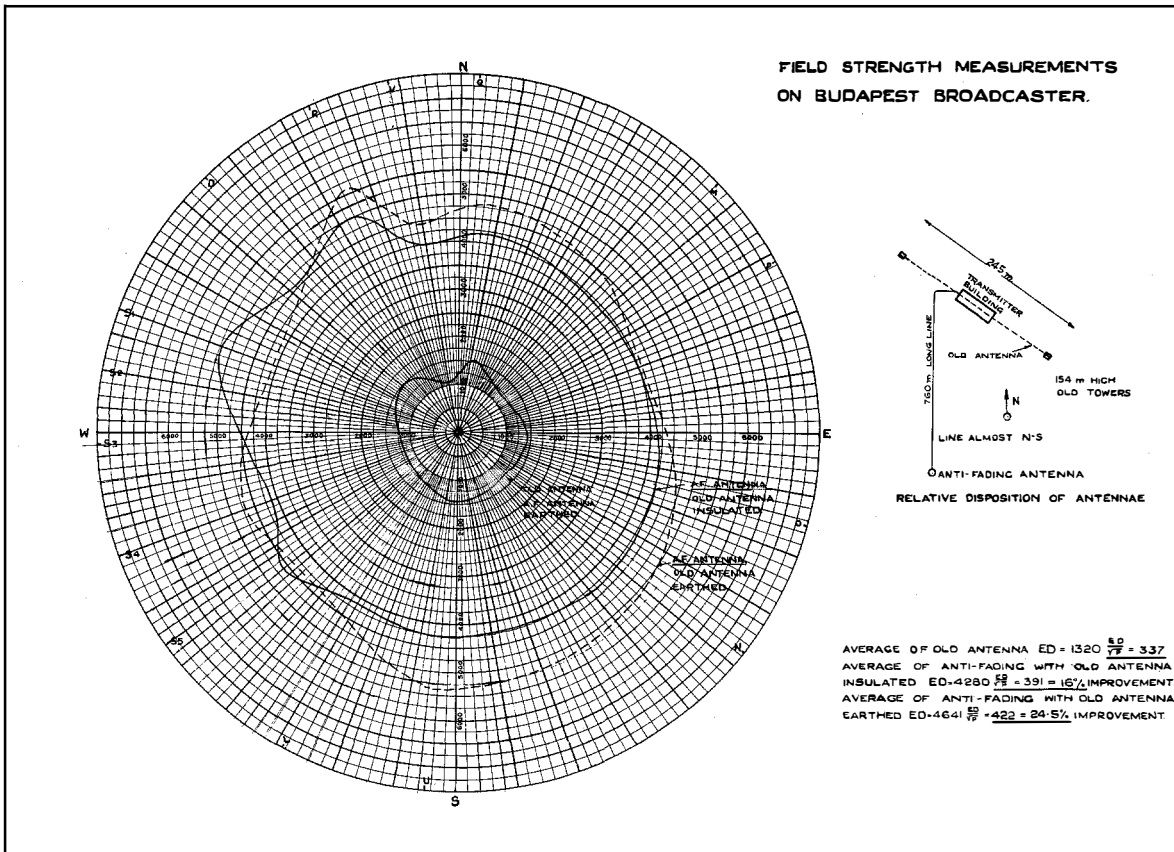
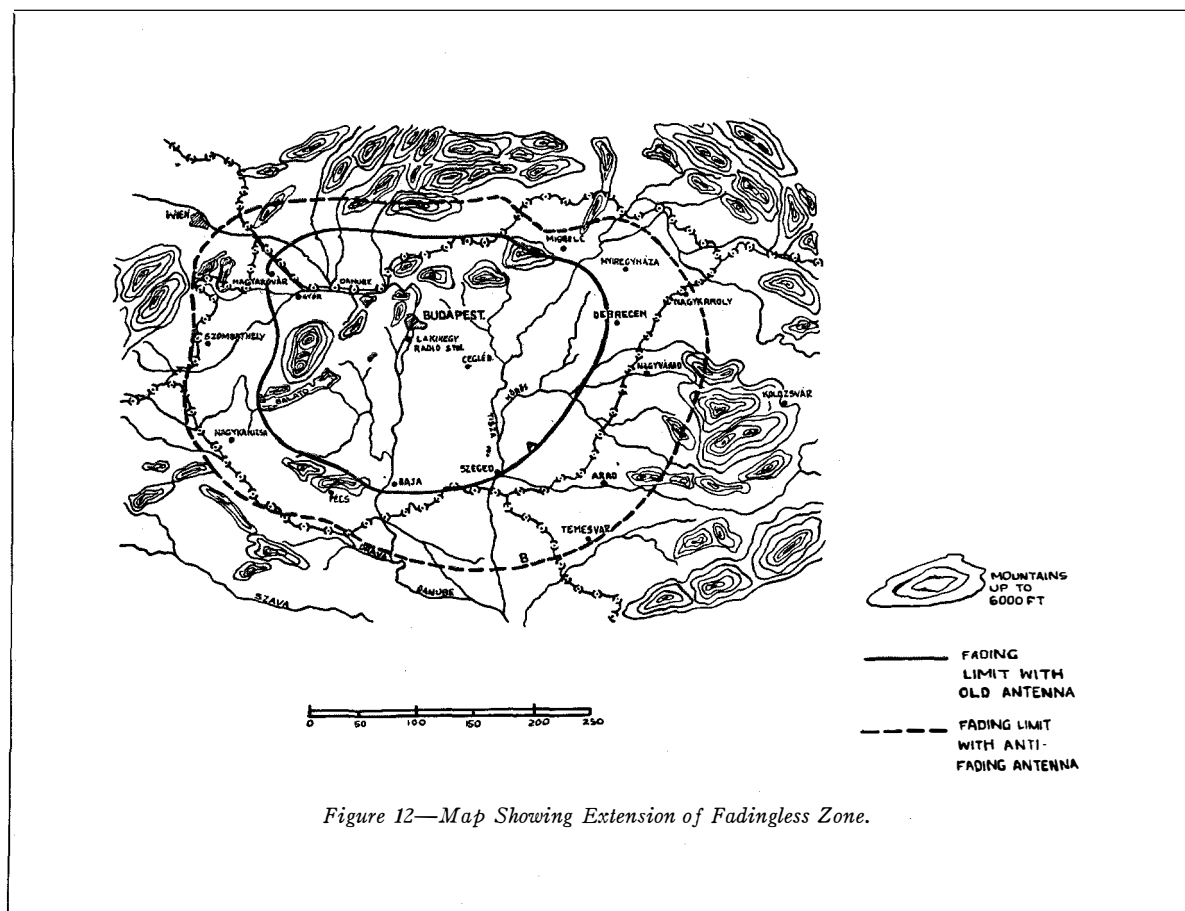

Figure 11—Field Strength Contour Map.



Merit of 422. The diagram is also more nearly circular, but the nature of the surrounding country renders an absolutely circular diagram improbable.

The measured antenna Figure of Merit of 422 is higher than the calculated maximum as shown in Fig. 3 for a loss resistance of 10 ohms, but agrees very closely with the value calculated on a basis of a loss resistance of 5 ohms.

Fig. 11 shows also the field strength results for the old high T antenna with an input of 15.3 kW.

This antenna has a ratio of $\frac{\lambda}{\lambda_0} = 0.63$. The measurements were made with the Blaw-Knox antenna earthed. The antenna Figure of Merit works out at 337, which agrees well with the value which would be predicted from Fig. 3.

From a comparison of the two results it appears that in the better case, the new antenna gives an increase of field in the horizontal plane of 24% as compared with the old antenna. Ex-

pressed in terms of transmitter power, this would be equivalent to an increase in carrier power from 120 kW. to 185 kW.

The increase in direct field combined with the simultaneous decrease in high angle radiation results in a very considerable enlargement of the area free from fading as may be seen from Fig. 12. From observations and reports received up to date, it appears that the limit at which fading becomes apparent to listeners has been extended from a distance of 120 km. for the case of the old high T antenna $\left(\frac{\lambda}{\lambda_0} = .63\right)$ to a distance of between 180 and 200 km. This is equivalent to more than doubling the service area of the station.

The results obtained have completely justified the sound judgment of the Technical Department of the Hungarian Administration in deciding to erect the tower. This decision required considerable initiative inasmuch as the structure is the largest of its kind in the world, and reflects

the greatest credit on the Hungarian Postal Administration, and especially on Messrs. J. Erdős and E. Magyari.

The responsibility for ensuring the soundness of the design and construction, as well as for verifying all possible requirements for safety, was

carried by Mr. P. Tanto of the Ministry of Commerce.

The general coordination of the project was arranged by the Standard Electric Company, Limited, Budapest, and in particular by Messrs. C. F. Detshy and C. György.



Swiss Broadcasting Studios

At left—Berne: Large Studio for orchestral broadcasts. The upper window looks into the Control Room and the lower, into the Announcer's Room.

At right — Geneva: Two independent control positions enable the Swiss National programme to be broadcast while a talk by a League of Nations official is transmitted over the International Telephone network for broadcasting in a foreign country.

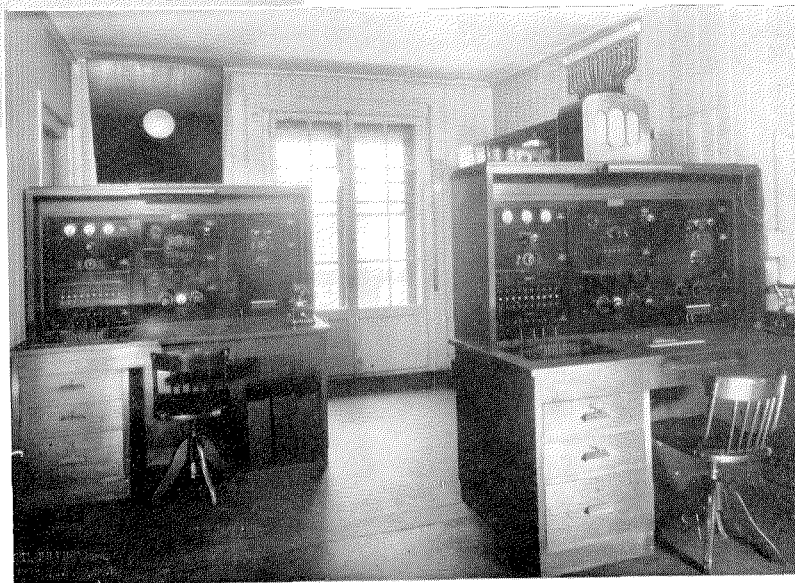

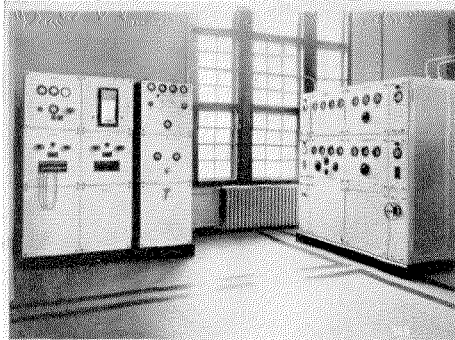

LINE AMPLIFIER HIGH STABILITY MASTER
OSCILLATOR AND OSCILLATOR MODULATOR UNIT

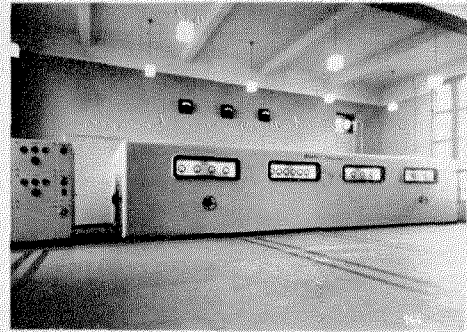

POWER AMPLIFIER UNIT

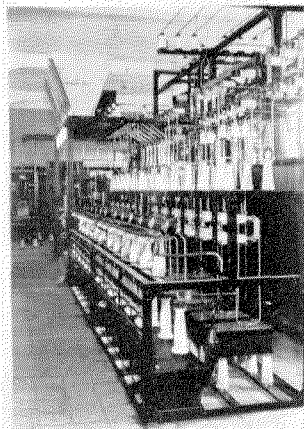

HOT CATHODE MERCURY VAPOUR
20,000 V. RECTIFIER

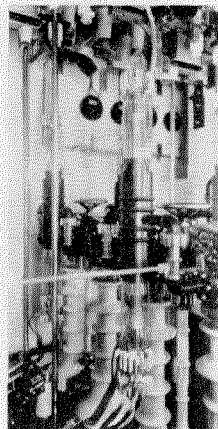

120 KW TUBE UNIT

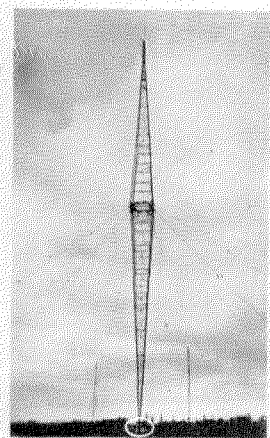

ANTENNA

BUDAPEST
120 KW
STATION

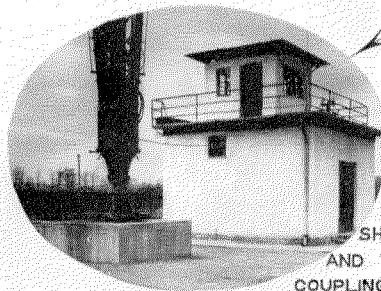

BASE OF ANTENNA
SHOWING INSULATORS
AND TRANSMISSION LINE
COUPLING STATION

Views of Budapest 120 kW. Station.

“Standard” High Power Broadcasting Transmitters at Budapest and Kalundborg

By C. E. STRONG

Central Laboratories

THE year 1933 was a year of extensive development of the broadcasting services in Europe and the Standard Companies took a very prominent part in the work involved. Eight new “Standard” transmitters were installed and put into service in that year. Of these stations, the two largest, namely, the 60 kW. transmitter at Kalundborg, Denmark, and the 120 kW. equipment at Budapest, form the subject of this article.

The Kalundborg equipment was built by Standard Telephones and Cables, Limited, with the cooperation of The Danish Post and Telegraph Administration, and the Budapest station was constructed by Standard Electric Company, Limited, Budapest, in cooperation with The Royal Hungarian Postal Administration.

Both transmitters were built according to the same general design, prepared by the Central Laboratories. They are, consequently, very similar in their main lines and may conveniently be described together. There are, however, a number of differences in the equipment in the two stations due chiefly to local regulations and individual wishes expressed by the Administrations concerned.

A distinctive feature of these stations is the form of construction of the power amplifier equipment, in that this apparatus, following the practice commonly adopted in the installation of indoor high voltage power plant, is installed in brickwork cubicles.

Other points of special interest are the use of a small number of valves of high power in the last stage, each having a reserve valve in position which can cut in at a moment's notice; the use of high efficiency mercury vapour rectifiers for the high voltage d-c. supply (Figs. 1-A and B); the reduction of the number of components and control circuits to an absolute minimum in the interest of reliability; the special design of the water cooling circuit; and the elimination of rotating machinery, except for the single fila-

ment machine and the water pumps, by the utilisation of dry metal rectifiers and hot cathode mercury vapour rectifiers for the low-power supplies.

The transmitters are laid out in single-story buildings having basements for the accommodation of water cooling plant and cable racks.

The layout of the Kalundborg station is shown in Fig. 2.

In the main transmitter hall (Fig. 3), we have the low-power radio unit, designated the “Oscillator-Modulator Unit,” the power amplifier cubicle, the power control board, water control board and the control desk. All the controls of the station are centralised in this room and, from his position at the control desk, the attendant can keep a watch on the meters both of the radio apparatus and of the power equipment.

Immediately behind the power board are the cubicles accommodating the high tension switch-gear, voltage regulators, meter transformers, etc., and behind the cubicles are three enclosures accommodating, respectively, the high voltage rectifier equipment, smoothing filters and the rectifier transformers, the latter being in vaults with access only to the outside of the building. On the opposite side of the building behind the water board is the room containing the low-power rectifiers for the oscillator-modulator unit and for grid bias supply, the control circuit contactors and the filament machine with its spare. The basement (Fig. 4), in which is installed the water cooling plant, is immediately below the transmitter hall, and from it a cable tunnel projects centrally under the part of the building devoted to power equipment.

In so far as the radio apparatus is concerned, the Budapest and Kalundborg transmitters differ only in the number of valves in the last stage of amplification. The radio frequency equipment is in two main sections—the low-power stages in the oscillator-modulator unit, and the intermediate and final power amplifiers installed in cubicle form.

The oscillator-modulator unit comprises five distinct units, as follows:

(a) The crystal controlled master oscillator, (b) two-stage amplifier unit, (c) modulated amplifier, (d) radio frequency amplifier following the modulated amplifier, and (e) three-stage voice frequency amplifier unit feeding into the modulated amplifier plate circuit.

Each of these units is in a separate box which

can easily be withdrawn from the main assembly for inspection. Each unit can, therefore, be individually tested by working into a suitable fixed impedance simulating the input impedance of the following stage so that the overall performance of the equipment can be logically analysed.

Accessory components, such as grid bias potentiometers and smoothing filters, anode

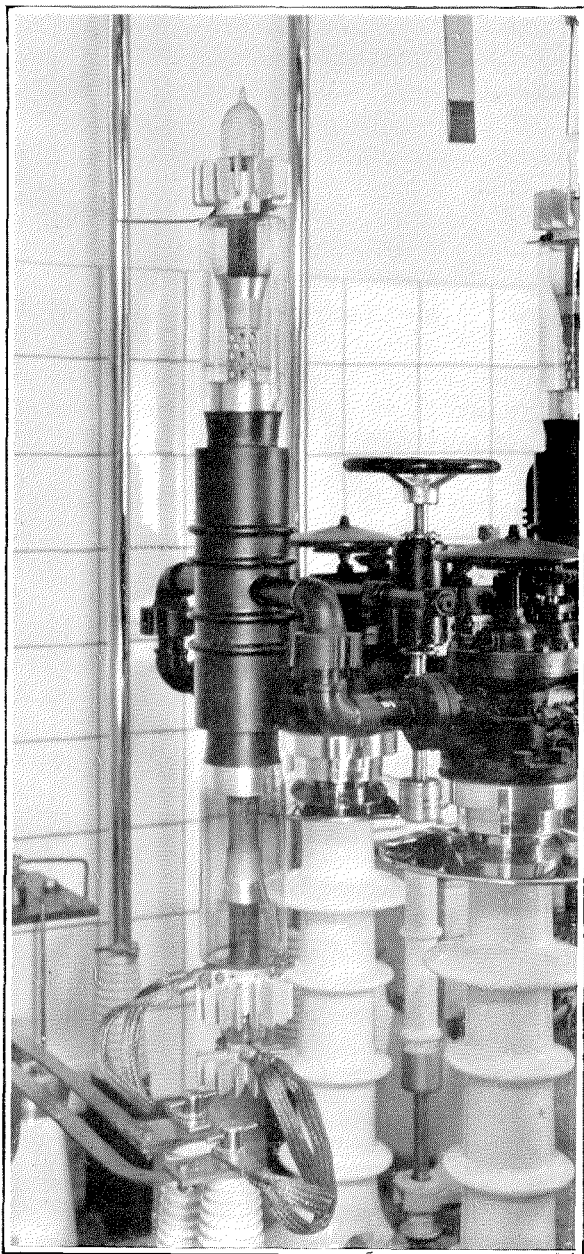

Figure 1-A—120 kW. Vacuum Tube—Kalundborg.

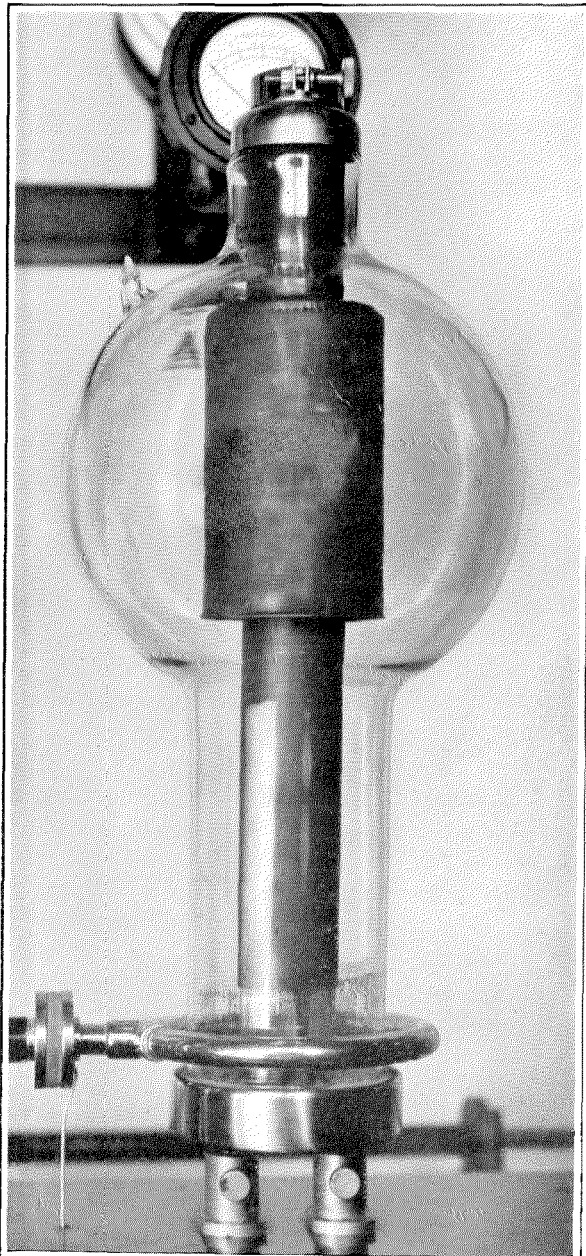

Figure 1-B—20,000 Volt, 250 kW., Hot Cathode Mercury Vapour Rectifier Tube—Kalundborg.

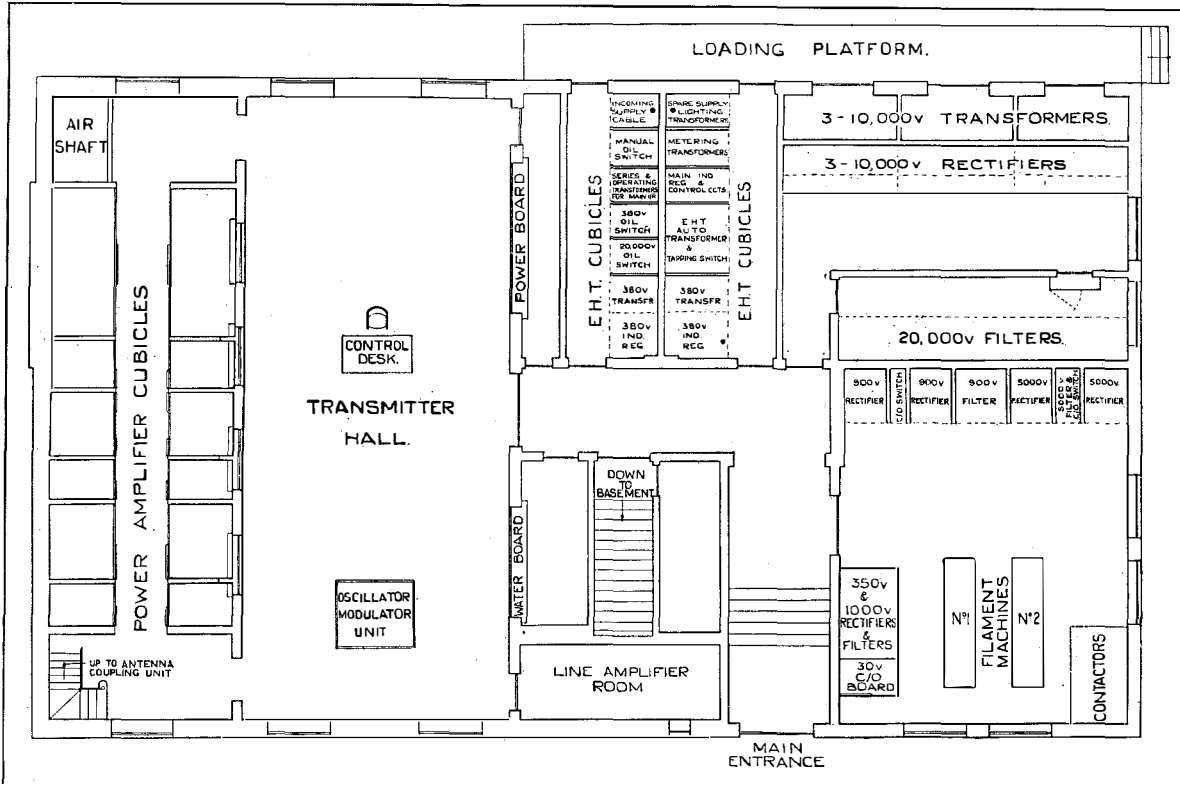

Figure 2—Layout of Kalundborg Station.

dropping resistances, etc., are installed on a number of rack-mounted panels with dust covers, situated in an accessible position inside the main framework to the rear. The doors of the main framework are mechanically interlocked with isolating switches to ensure full protection to personnel.

The output of the oscillator-modulator unit can be modulated to 95% without the introduction of distortion products exceeding 5% of the fundamental in amplitude. The output circuit is designed to feed into a resistance potentiometer grounded at the centre, having a tapping at each side going to the grids of the first stage in the amplifier cubicle. By means of this potentiometer the drive on the amplifiers can be adjusted to the required level.

The cubicle contains two stages of amplification referred to respectively as the Intermediate Amplifier and the Power Amplifier. Both stages are in push-pull and both work with an anode voltage of 20,000 volts.

The cubicle is divided into two halves by a corridor which runs longitudinally from one

side to the other, and each half is again divided into compartments by transverse partitions. The apparatus is disposed symmetrically about the central corridor in accordance with the symmetry of the push-pull circuit. The corridor is fenced off on each side by expanded metal partitions in which there are gates leading into the several compartments. These gates are mechanically interlocked with the high tension isolating gear. The compartments are indirectly lighted and the apparatus can be inspected from the corridor while in operation. The cubicle is electrically shielded by copper mesh built into the walls, floor and ceiling to prevent the radiation of harmonics generated by the amplifiers.

The measuring instruments are mounted behind plate glass in recesses in the wall of the cubicle in the transmitter hall. The meter faces are illuminated by lamps concealed around the edges of the recesses. On the wall above the cubicle in the transmitter hall are mounted three large meters indicating amplifier plate voltage, total plate current and antenna current. Their faces are illuminated from the back.



Figure 3—(Upper) Oscillator-Modulator Unit, Control Desk and Front of High Voltage Radio Frequency Cubicle. (Lower) Power Board and Water Control Board.

The number of compartments on each side of the corridor is six. The first three are devoted to the intermediate amplifier and the remainder to the power amplifier. The corridor and the layout of the compartments on one side of the push-pull circuit are shown in Figs. 5 and 6. Fig. 6 is false in perspective, as it is made up of a number of photographs taken from different angles.

The first compartment contains the valves of the intermediate amplifier (Fig. 7). There are two 30 kW. valves on each side of the push-pull circuit, one of which is in reserve. The reserve valves can be quickly cut in by means of three-pole change-over switches.

In the second compartment is installed the intermediate amplifier output circuit. The large condenser seen in the centre of the photograph is the anode stopping condenser. Although the normal working voltage is 20,000, the condenser is rated for a working voltage of 30,000, allowing an adequate reserve for the heavy surges which are set up on the occurrence of a "flash arc" or

Rocky Point effect in a valve, causing a temporary short-circuit on the high voltage circuit. To the right, mounted on a bracket on the wall, may be seen one of the two oil filled neutralising condensers used to balance the plate to grid capacity of the valves.

The carrier power output from the intermediate amplifier is 5 kW. for a 60 kW. transmitter, and 8 kW. for a 120 kW. transmitter. The power is dissipated in water cooled resistances in parallel with the grids of the power amplifier. These resistances are installed in the third compartment in which are also located the grid stopping and by-passing condensers and filament circuit equipment of the power amplifier.

The fourth compartment is the valve compartment of the power amplifier (Fig. 8). In the 60 kW. transmitter there is one 120 kW. valve with a second in reserve on each side of the push-pull circuit. In the 120 kW. equipment there are two 120 kW. valves in operation and two in reserve on each side of the circuit, making in all



Figure 4—The Basement at Kalundborg.

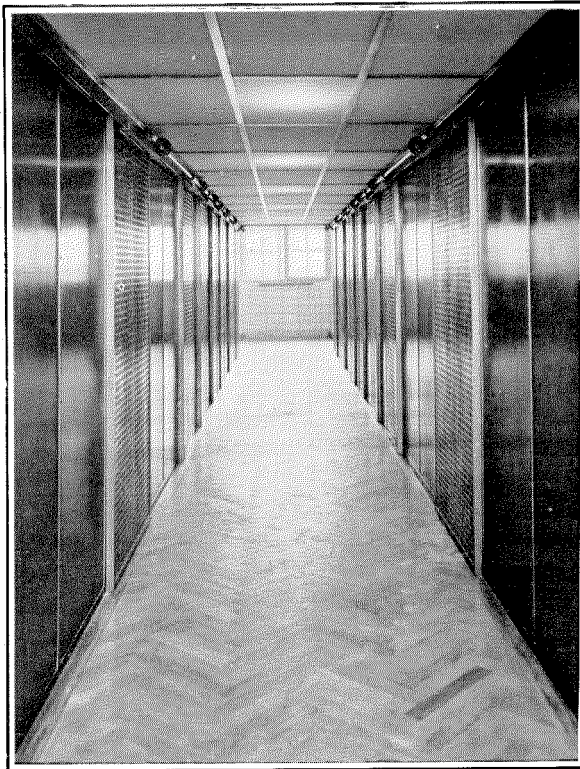

Figure 5—Corridor of Amplifier Cubicle.

four valves in operation with each valve having a reserve associated with it. Each pair of valves, one valve in operation and the other in reserve, is mounted on a pair of tall porcelain insulator bushings which project through the floor of the cubicle into the basement beneath. The bushings have a channel through the centre and the cooling water is brought up through one bushing and

leaves through the second of the pair. For the purpose of changing over from one valve to its reserve, a mechanism is provided for each pair by means of which the cooling water and the filament and grid connections are simultaneously switched over.

The mechanism for each pair of valves is operated by a handwheel located between them. This handwheel controls the water cocks directly and, driving through porcelain shafts, operates the grid switch above the valves and the filament change-over switch in the previous compartment. The change-over may thus be completed in a matter of seconds. The grid and filament switches are insulated for 20,000 volts so that a valve which has failed and been cut out by the change-over mechanism can be left in position no matter what was the cause of failure, whether a complete internal short circuit or a burst water jacket, or any other fault. In the case of the valve compartments, the expanded metal gates are backed by glass so that if a leak should occur in the water system within the cubicle there will be no danger to personnel due to contact with a jet of water at high voltage.

The fifth compartment contains the oil filled balancing condensers, and the anode feed circuits of the power amplifier valves. Each valve in operation has a separate 30,000 volt stopping condenser and anode choke coil. In series with each anode choke coil is a 20,000 volt fuse and a device for registering momentary overloads in the valves, as such short-time overloads do not trip the circuit breaker owing to special provisions made to secure that result.

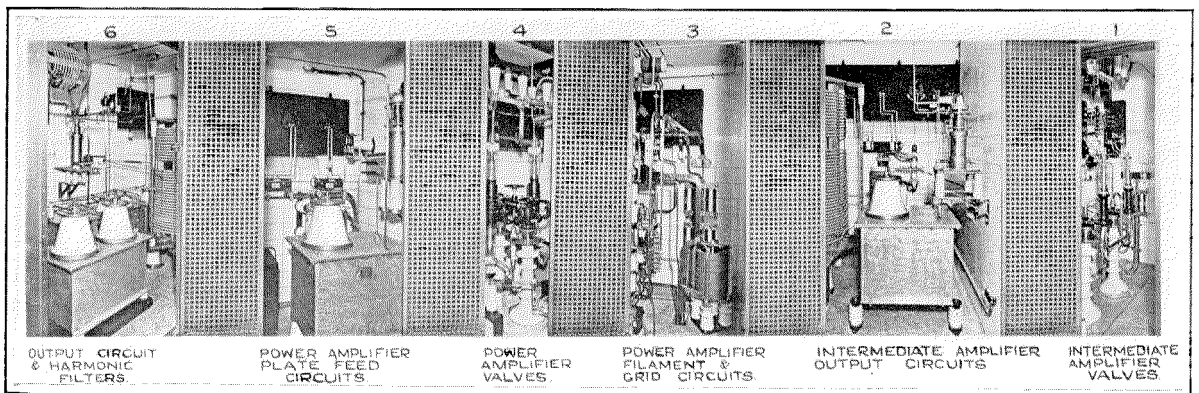

Figure 6—Kalundborg Transmitter—Layout of Cubicle Compartments on One Side of Corridor.

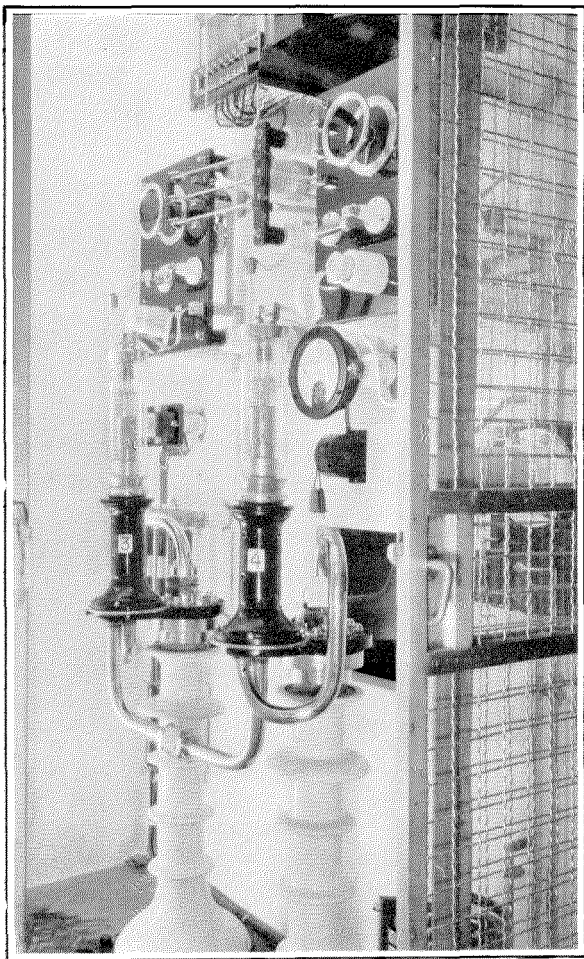

Figure 7—Budapest Intermediate Amplifier Valve Compartment.

The sixth compartment accommodates the output circuit and harmonic filters on one side of the circuit, also half of a 600 ohm water cooled artificial antenna. The output circuit feeds into a balanced 600 ohm transmission line going to the antenna tuning and coupling circuits. The 600 ohm water cooled antenna is capable of dissipating continuously the normal output of the transmitter when fully modulated. It can be switched in, in place of the antenna transmission line for testing. Accurate thermometers and a flow meter are provided so that the power dissipated in the artificial load can be precisely determined.

The harmonic filters in the sixth compartment provide sufficient attenuation to ensure the requisite suppression, account being taken of the

harmonic radiation which could occur from the antenna transmission line.

Fine adjustment of the tuning of the output circuits of the intermediate and power amplifiers is provided for by short-circuited turns operated from handwheels on the front wall of the cubicle. These controls when once set do not require day-to-day adjustment.

The meters in the recesses in the front wall of the cubicle include a plate current and grid current meter for each valve, circulating current meters in series with fixed reactances across the grid indicating the RMS grid swing on each side of the push-pull circuit of both amplifiers, power amplifier output circuit coupling leg meters on each side and transmission line current meters on each side of the line. The feed current of the antenna itself is registered on one of the large

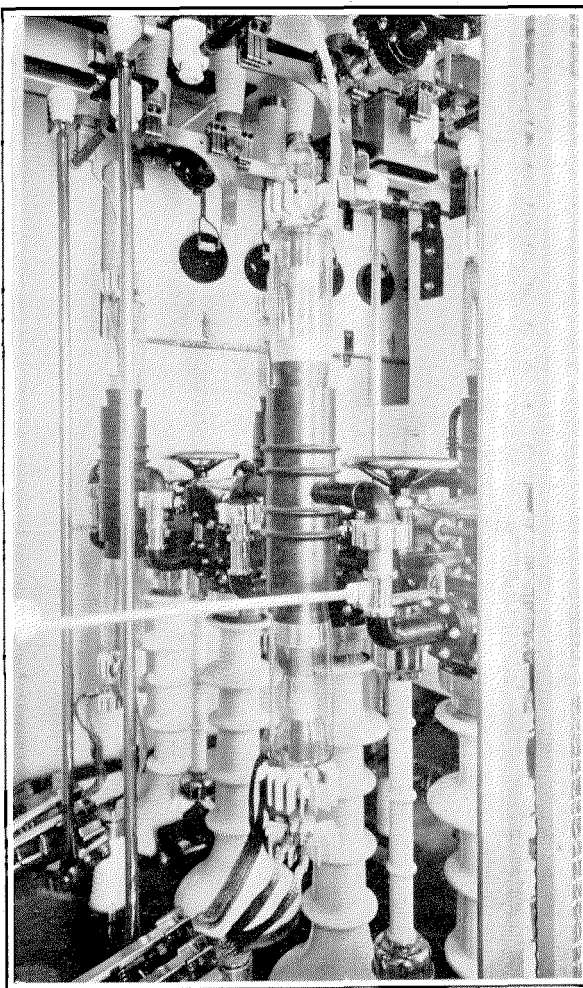

Figure 8—Budapest 120 kW. Valve Compartment.

meters above the amplifier cubicle, as mentioned before.

Monitoring rectifiers are connected permanently to the output circuits of the oscillator-modulator unit and of the intermediate and power amplifiers. Their output leads are brought to the control desk where they can be switched either to a modulation meter or a cathode ray oscillograph, both mounted in the desk. These monitors are used for routine observation of the modulation and for taking load curves and frequency response curves at the output of each of the three main sections of the transmitter.

It will be clear from the description which has been given and from the photographs that the cubicle construction as applied to the high power radio frequency equipments permits an ideally logical layout of components considered from the point of view of the electrical circuit. The use of the walls as supports for components results in economy of floor space. Large components as required for adequate factors of safety are neatly accommodated without sacrifice of accessibility, satisfactory shielding of harmonics is obtained and full protection of personnel is ensured.

The water cooling system of a large radio station requires careful design. The system adopted at Budapest and Kalundborg comprises a closed primary circuit in which distilled water is used, and a secondary circuit in which is circulated sea water in Kalundborg and well water in Budapest. A schematic diagram of the primary circuit at Kalundborg is given in Fig. 9. The circuit for the 120 kW. transmitter is the same except that there are separate feeders for the power amplifier valves on each side of the push-pull circuit.

The distilled water is contained in a tank in the basement. The water is drawn from the tank by the primary circuit pump, and passed through the water-to-water cooler to the main header situated in the basement immediately below the water control board in the transmitting hall. From the main header the water is distributed to the feeders, of which there are three in Kalundborg and four in Budapest. In Kalundborg, the first feeder is for the valves of the intermediate amplifier on both sides of the push-pull circuit. The second feeder serves the valves of the

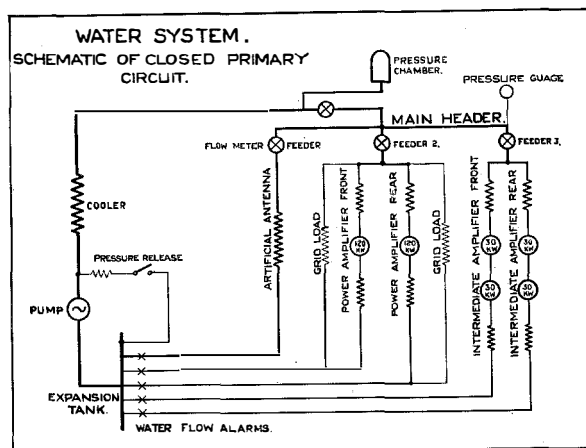

Figure 9—Diagram of Kalundborg Water System.

power amplifier and the water cooled grid resistances, and the third feeder is for the water cooled artificial load. The outlet from each valve is brought back separately to the tank, and in each return pipe there is a water flow alarm provided with electrical contacts arranged so that if the flow falls below a specified value the transmitter is shut down to save the valves from suffering damage.

The water is led up to and away from the valves through porcelain coils providing sufficient length of water column to obtain the necessary high resistance between the valves at 20,000 volts and the rest of the system at ground potential to avoid serious electrolysis. There is one inlet and one outlet coil for each 120 kW. valve in operation, and one two-way coil for each of the two intermediate amplifier valves. These porcelain coils (Fig. 10) are installed in the basement immediately below the valve supporting bushings through which the water is led to and from the valves.

The supplies to the feeders are regulated and measured at the water control board in the transmitting hall. A photograph of the Kalundborg board is given in Fig. 11. The board comprises four panels. The first is for the control of the supply to the main header and the three others are for the feeders. The large meters indicate the flows in litres per minute. Of the three smaller meters on the first panel, one reads main header pressure in kilograms per square centimetre and the remaining two indicate the temperature of the water at the main header and the tempera-

ture at the tank. The small meters on the second and third panels read the temperature at the outlet of each valve, and those on the fourth panel indicate the inlet and outlet temperatures of the artificial antenna. The thermometers have electrical contacts which can be set to give an alarm if the temperature exceeds a given value.

The main control on the first panel is operated nearly full open and the feeder controls are set to obtain the specified feeder flows. By keeping a record of the feeder control settings required to maintain the specified flows, early warning is given of any increase in the hydraulic resistance in the feeder circuits. The flow in the first feeder to the valves of the intermediate amplifier is 120 litres per minute, and the flow in the second feeder for the two 120 kW. valves and the grid resistances is 280 litres per minute. The artificial load when in operation takes 100 litres per minute in the 60 kW. transmitter and 200 in the 120 kW. equipment.

The system is operated with a main header pressure of between three and four kilograms

per square centimetre. A pressure release valve is provided at the outlet of the pump which can be set to open at a given pressure, thus limiting the maximum pressure sharply to the chosen value.

In order to take full advantage of the factors of safety for pressure allowed in the various parts of the system, particularly in the valve jackets, a shock absorber in the form of an air pressure chamber is included in the system. In this way the necessity of designing the system for "live" loads was avoided.

The hydraulic conditions in the system are recorded in pressure level diagrams prepared for each feeder, together with the part of the circuit common to all feeders. Such a diagram is shown in Fig. 12, representing the case of the feeder to the two 120 kW. valves of the power amplifier at Kalundborg. The system is designed to have good pressure regulation so that adjustment of the flow in one feeder does not materially affect the flows in the others.

A spare cooler is included in the equipment of

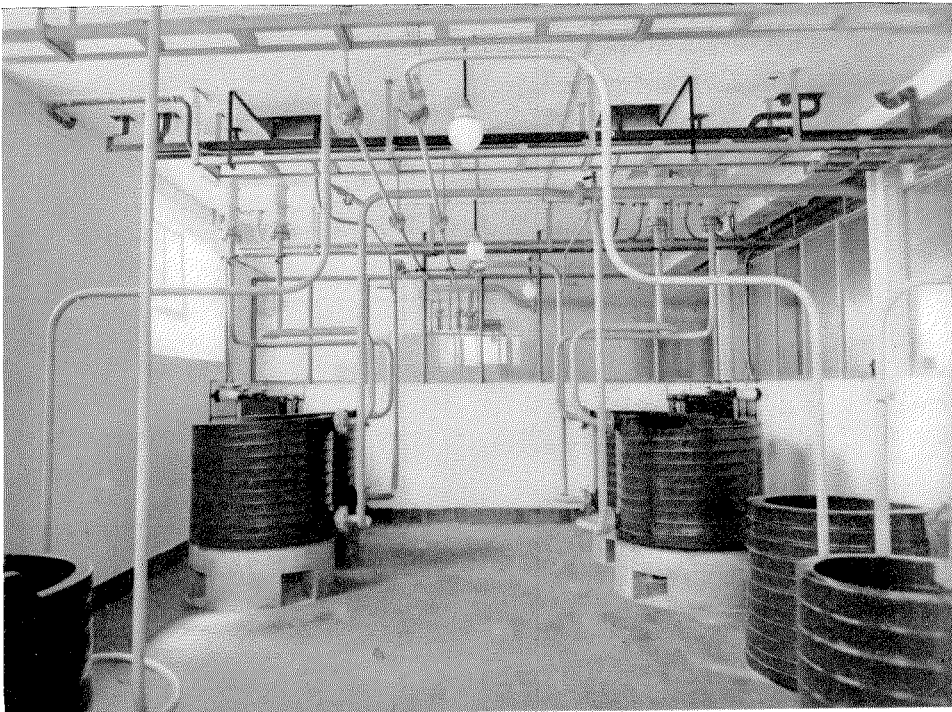

Figure 10—Kalundborg Porcelain Water Coils.

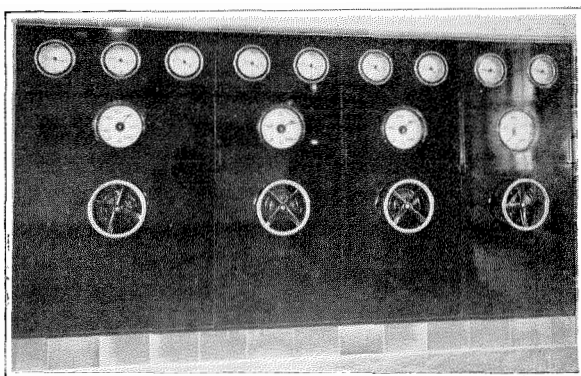

Figure 11—Kalundborg Water Control Board.

the transmitting stations. The one installed in Budapest is a water-to-water cooler similar to the regular equipment, while the reserve plant at Kalundborg is an air blast cooler. This type of reserve cooler is used at Kalundborg to avoid a shut-down which might result from a stoppage in the sea-water intake to the regular cooler under exceptional weather conditions.

The power supply equipment of the 60 kW. and 120 kW. stations is the same in general conception. The representative case is shown diagrammatically in Fig. 13.

Reliability has been the first consideration and an outstanding feature of the equipment is its straightforward simplicity. It was the aim to achieve full protection for personnel, logical sequence of operations, and the necessary interlocking and signalling to protect valves and other equipment in case of a fault, with an absolute minimum of complication both in circuit and components.

The next consideration was efficiency, and this led to the use of mercury vapour rectifiers (Fig. 14) for the high power high voltage d-c. supply.

Dry metal rectifiers and hot cathode mercury vapour rectifiers are used for the low-power supplies for the oscillator-modulator unit and for grid bias. This results in simplification of the problem of voltage regulation, since all the low-power supplies can be controlled by a single a-c. automatic regulator; it also saves maintenance by reducing the number of rotating machines. The 26 volt filament supply is the only one for which a machine is used, and in that case the

voltage is maintained constant by means of a d-c. automatic regulator.

The Kalundborg power control board, which may be seen to the left in Fig. 3 (lower), is made up of four panels. The first panel, on the left, is the incoming supply panel concerned with the energising and metering of the 10,500 volt main bus bar. The handwheel on the left is for selecting either of two incoming cables, and the one on the right controls the main oil switch which is mechanically interlocked with the gates of the power equipment cubicles behind the board.

The second panel is for the feeder to the 380 volt transformer energising the main 380 volt bus bar feeding the filament machine, pumps, grid bias rectifier, air blast cooler, etc., and the 380 volt regulated bus bar supplying the low-power rectifiers for the oscillator-modulator unit and the filaments of the 20,000 volt high-power rectifier. The 380 volt feeder oil switch is electrically operated by a push button on the control panel. The small handwheel to be seen on the panel is for working an isolator interlocked with the doors of the fuse recesses.

The third panel is for the control of the 26 volt d-c. filament machine. The d-c. automatic voltage regulator is mounted on this panel.

The fourth panel is the feeder panel for the 20,000 volt rectifier supplying the anodes of the intermediate and power amplifiers. The 20,000 volt feeder oil switch is electrically operated from buttons on the panel. The handwheel on the panel operates the tapping transformer for varying the voltage under load.

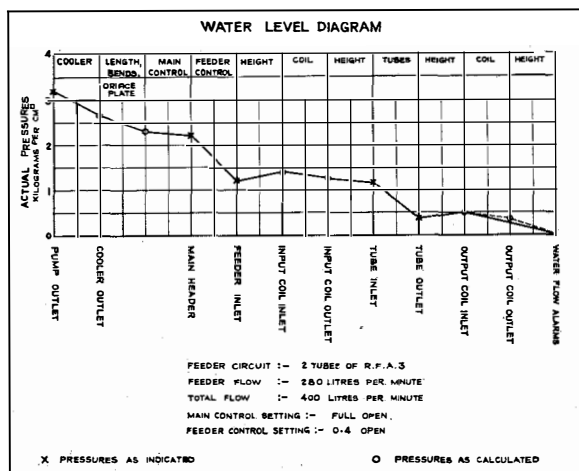

Figure 12—Water Circuit Level Diagram.

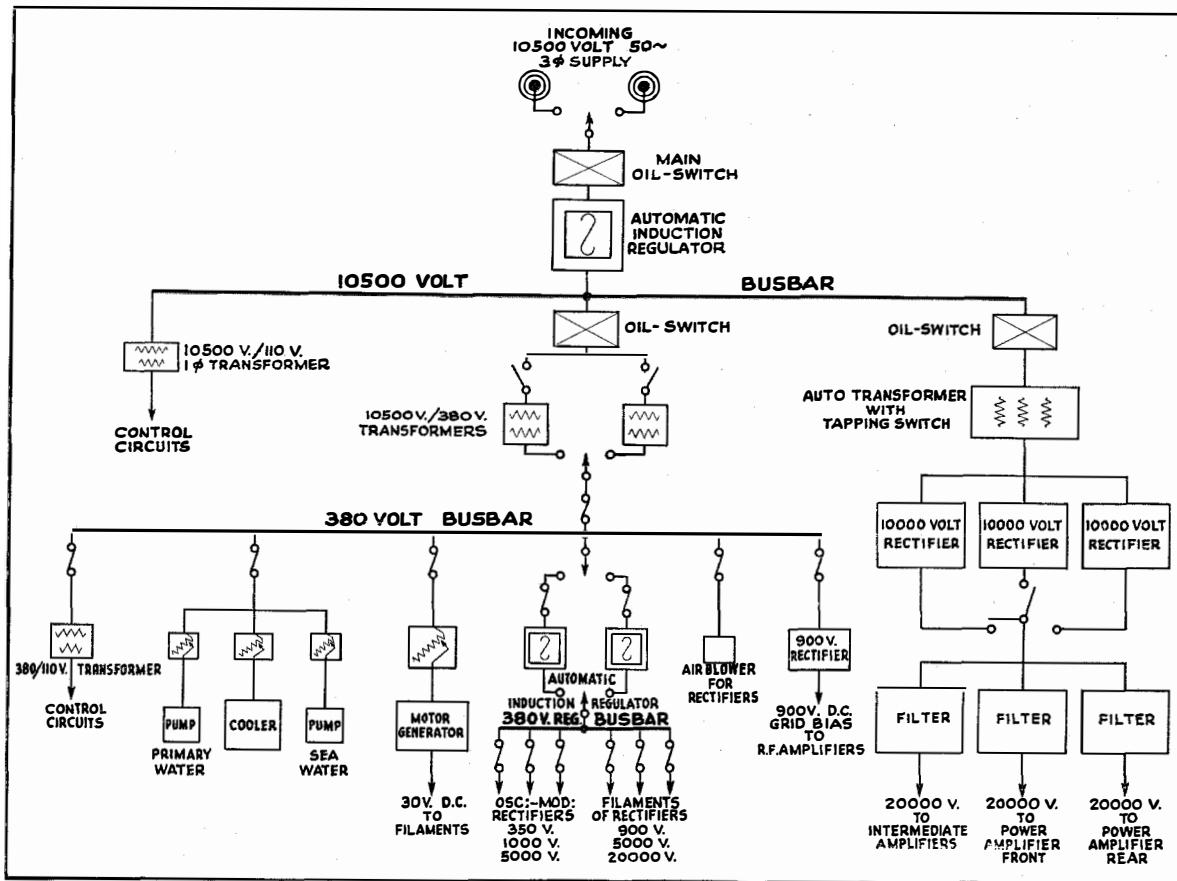

Figure 13—Schematic Diagram of Power Circuits.

The low power rectifiers for the oscillator-modulator unit and for grid bias supply are in duplicate and means are provided for switching over quickly to the reserve equipment, leaving the other set completely isolated and free to be attended to. The rectifiers are mounted in free standing units as indicated in Fig. 13. One unit contains two complete 5,000 volt rectifiers, one in the upper half and the other in the lower half of the unit with the change-over gear in the centre section. A second unit contains similarly two 900 volt grid bias rectifiers. These sets are three-tube hot cathode mercury vapour rectifiers.

The third unit contains two sets of 380 volt and 1,000 volt dry metal rectifiers, and the fourth unit contains the control circuit contactors and the main grid bias potentiometer.

The 20,000 volt rectifier equipment is required to deliver 12 amperes in a 60 kW. station and about double that in a 120 kW. station.

The Kalundborg equipment is a "Standard" hot cathode mercury vapour rectifier comprising three 10,000 volt six-tube sets, any two of which may be run in series, the third unit being held as reserve. The overall efficiency of this equipment including transformers, and taking account of necessary transformer damping resistances, but not taking account of resistances in series with the radio valves to protect them from surges in case of short circuit, is 94% and the power factor is .9. Each rectifier tube is separately fused and the very important result is achieved that if a tube fails it cuts itself out without interrupting the programme and need not be replaced until there is a normal intermission in the programme.

In Budapest the 20,000 volt supply is taken from either a Brown Boveri tank type mercury arc equipment or from a "Standard" hot cathode mercury vapour rectifier of the type described

above. The tank type rectifier is of the pattern developed by the Brown Boveri Company of Baden, Switzerland, and is the first equipment of this type operating at 20,000 volts. The arc is formed in a steel tank which contains the necessary formed electrodes and which is kept continually evacuated by means of auxiliary pumps. In addition to the rectifying electrodes, the rectifier is equipped with control grids designed to limit the effect of overload in the external circuits and "arc-back" in the rectifier. The efficiency of the Brown Boveri rectifier and the power factor on full load are approximately the same as for the hot cathode mercury vapour rectifier.

The 20,000 volt rectifier works into three filters, one feeding the intermediate amplifier and the other two feeding the two sides of the power amplifier. By this arrangement we get minimum plate remodulation for a given investment in condenser KVA and maximum current limitation in the case of a short circuit in the radio valves.

Resistances are included in series with the filter chokes and again in the anode feed circuits to the valves of the intermediate amplifier and to each separate valve of the power amplifier to limit the maximum short circuit current and to suppress surges in case of "flash arc." Extra resistances normally shorted by fuses are inserted in series with the smoothing chokes. In the case of a persistent "flash arc" the fuses blow, cutting in the extra resistances which in general stop the arc without interruption of service. Only in the worst cases is the 20,000 volt circuit breaker opened, causing an interruption in the transmission until the voltages can be brought on again by the operator.

In regard to performance, it is sufficient to say that the standards generally recognized and formulated by the C.C.I.R. have been fully met by these transmitters, and the reliability is up to

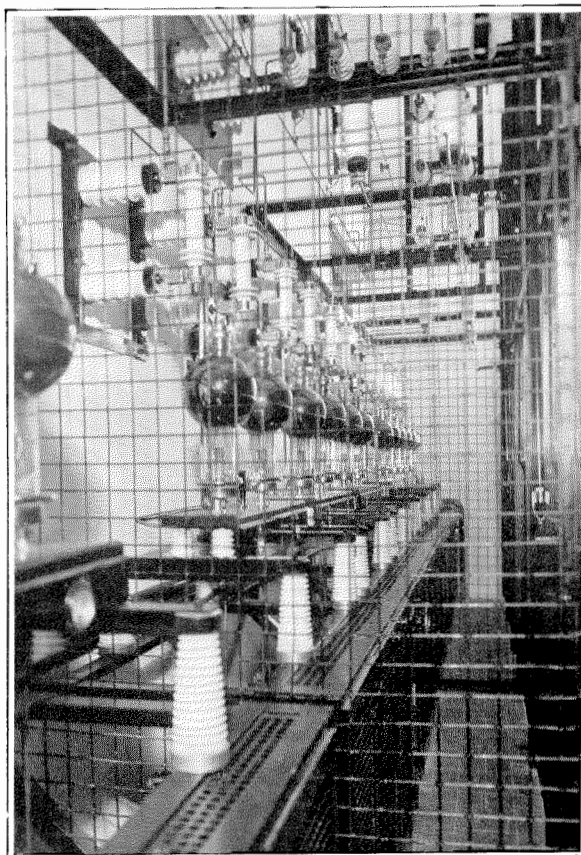

Figure 14—20,000 Volt Rectifier Equipment.

the highest attainment of modern practice.

In the successful realisation of these projects, we owe very much to the wholehearted cooperation of the Administrative Authorities concerned, and we desire to express our grateful appreciation for the technical assistance and friendly help accorded by Mr. Kay Christiansen, Chief Engineer of The Danish Post and Telegraph Administration and his Consulting Engineer, Mr. Rob. Henriksen, as well as to Mr. Tersztiánszky, Chief Engineer of The Royal Hungarian Postal Administration and his assistants, Messrs. J. Erdös and E. Magyari.

Automatic Long Distance Switching and National Dialing—Basle, Switzerland*

By E. FREY, *Basle*

AUTOMATIC telephone operation having shown good results in city as well as in rural service, the Swiss Telephone and Telegraph Administration also undertook consideration of the automatization of the toll service.

Such a project, for which many solutions can be envisaged, obviously required a thorough study of all the technical and particularly the economic questions connected therewith, and could only be carried out in stages. The first step in the direction of automatization of the Swiss toll plant was completed in 1930 with the opening of the automatic toll service between the two cities of Berne and Biel.

The new service, introduced in Basle in 1933, represents a second step involving a series of new features and operating methods not previously used. The equipment involved (the 7-D Rotary System) was supplied by the Bell Telephone Manufacturing Company, Antwerp, and was placed in service in the spring of 1933.

1. Automatic Toll Service Between Basle and Zurich

A. GENERAL

In the general project for the automatization of the Swiss toll plant, a 2-digit prefix has been assigned to the main switching and tandem centers: Basle, 06; Zurich, 05; Berne, 03; Lausanne, 02; etc. Later on, when tandem service is started, a 3-digit prefix will be used: 061 for Basle; 051 for Zurich; 031 for Berne; 021 for Lausanne; 022 for Geneva; etc. By sending this prefix, any subscriber of the particular city and

* Translation of a paper from *Technische Mitteilungen*, Bern, 1, XII, 1933, No. 6, published in German and French under the titles: "Städtewahl und Schnelldienst in Basel" and "La sélection intervilles et le service rapide à Bâle," respectively. Permission granted by the author and Direction Générale des Postes et des Télégraphes suisses to republish this paper is gratefully acknowledged.

of the district surrounding that city can be reached automatically without the intervention of an operator. From Basle to Zurich, and vice versa, 1400 to 1500 connections are established daily in each direction on an automatic basis, or a total of approximately 3000 calls daily. For handling this traffic there are available:

| | |
|--|---------------|
| Direction Basle-Zurich (Automatic Toll) | 22 Toll Lines |
| Direction Zurich-Basle (Automatic Toll) | 22 Toll Lines |
| Two-way Circuits between the two towns for Manual Traffic | 8 Toll Lines |
| Total | 52 Toll Lines |

The automatic toll lines are so designed that they can be used also for automatic long distance dialing by toll operators.

Subscribers can establish their own interurban connections by means of the dial or ask for them as heretofore by calling the recording service—No. 14. They have been quick, however, to realise the advantages of direct automatic selection since, only a few months after the introduction of the new system, 85% of all connections were thus established. The remaining 15% represent in the case of Basle about 230 connections a day. For handling these 230 connections, two operators are required. Statistics show that these 230 calls are made up as follows:

- Subscribers in 125 cases wished the calls to be established manually.
- Subscribers in 63 cases did not know the calling number of the distant subscriber.
- In 42 cases the connection was directed to overflow, inasmuch as all the lines were busy.

The preference given to the automatic service is shown by the fact that one-third of the subscribers whose calls, owing to lack of circuits, went to the overflow position, declined the overflow toll operator's assistance but chose rather to establish their connections themselves as

soon as a line was available. The decrease of $\frac{1500 \times 85}{100} = 1275$ calls a day (Basle or Zurich) heretofore put through manually, taking into account an average of 32 outgoing calls an hour, results in a saving of about 40 operator hours; that is, approximately five service shifts or, if 1.2 operators per shift be counted, six operators.

Since the capital investment in toll lines is considerably more important than in the exchange equipment, an important economy is realisable if it is made possible to use the toll lines more efficiently. With the progress of automatization and replacement of overhead lines by underground cables, the tendency is more and more to reduce the number of traffic channels by cutting out tie lines and direct connections between unimportant places. Small groups of lines are combined as much as possible in large groups which permit (following principles applied in automatic working) more efficient use of the lines (See Fig. 1).

The future Swiss toll network, accordingly, will have a structure approximately as illustrated in Fig. 2.

Whenever the traffic between two important cities justifies a direct group of lines, such direct toll lines will be established (Basle to Zurich; Zurich to Berne; etc.).

When carrying out a project such as converting the interurban service to automatic working in stages, it may often be difficult to make available the required number of toll lines for no-delay service. At the time of cutover of the Basle-Zurich automatic service, the traffic of 2000 call-minutes per busy hour, in accordance with the traffic curves, required 50 toll lines with a delay of 1% - $1^0/_{00}$ whereas only 44 lines were available. The automatic service, however, increased the efficiency of the lines (increase of effective minutes, reduction of time lost in building up connections, cutting out of service conversations over the lines, and instantaneous releasing of lines) and reached a figure better than that illustrated by Fig. 1, which represents the normal efficiency, so that in Basle only 60 calls were transferred to overflow during the busy hours from 9 to 12 noon, or 20 per busy hour. With 500 equated busy hour calls in each direction (1000 call-minutes) the overflow calls in these

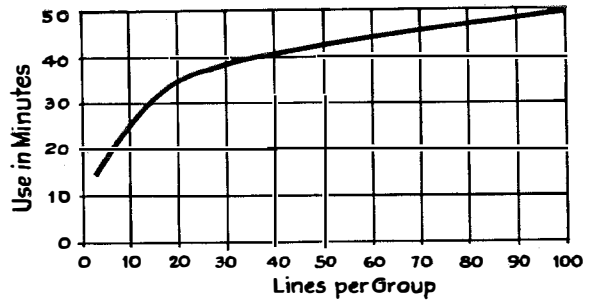

Figure 1—Use of Line Groups in Rapid Service with 1% Loss

busy hours represent a delay of 4%. If one considers that these calls are not lost,—as would frequently be the case in local traffic where busy calls are not always repeated later on,—but in automatic operation are routed to an overflow position for manual establishment, the method of handling such delayed connections can be considered as absolutely normal. Results, therefore, exceed the expectations.

A comparison of line observations based on three toll operating methods—manual service, long distance dialing by operators, and full automatic toll operation—shows the following line efficiency:

I. Manual service (two operators with local automatic switching). 67 connections in 7 hours, or an average of 10 per hour.

1. Minutes not paid (not charged):

- (a) For service conversations 3' 04"
- (b) Until the subscriber answers 6' 18"
- (c) For releasing connections 0' 52"
- (d) Other miscellaneous losses 1' 59" 12' 13"

2. Paid minutes (charged minutes):

- (a) Paid conversation time 42' 29"

3. Line time not used 5' 18"

Total 60' 00"

II. Toll operation with long distance dialing by operators and automatic local switching (1 operator)

90 connections in 7 hours, or an average of 13 connections per hour.

1. Minutes not paid (not charged):

- (a) Time for establishment of connections (sending of numbers) 2' 46"
- (b) Until the subscriber answers 4' 03"
- (c) For releasing connections 0' 42"
- (d) Other miscellaneous losses 0' 45" 8' 16"

2. Paid minutes (charged minutes):

| | |
|----------------------------|---------|
| (a) Paid conversation time | 45' 33" |
| 3. Line time not used | 6' 11" |
| Total | 60' 00" |

III. Full automatic toll operation (no operator).
 96 connections in 7 hours or an average of 14 connections per hour.

1. Minutes not paid (not charged):

| | |
|--|--------|
| (a) Time for establishment of the connections (sending of numbers by the subscriber) | 1' 40" |
| (b) Until the subscriber answers | 3' 57" |
| (c) For releasing the connection | 0' 00" |
| (d) Other miscellaneous losses | 0' 48" |
| Total | 6' 25" |

2. Paid minutes (charged minutes):

| | |
|----------------------------|---------|
| (a) Paid conversation time | 48' 42" |
| 3. Line time not used | 4' 53" |
| Total | 60' 00" |

These summaries show the following advantages:

With the progress made in and growth of

automatic systems, efficiency is improved. As compared with manual service, long distance dialing by the originating operator increases the number of charged (paid) minutes by 3; while long distance dialing by the originating subscriber increases the paid minutes to 6.

The subscriber, who is not usually otherwise occupied, takes 84 seconds less for putting through 14 connections in an hour than is required by two operators in the case of manual service for putting through 10 connections in the same period of time.

Periodic ringing (every 5 seconds) of the desired subscriber, both in long distance dialing by operators and in full automatic toll service, reduces the answering time of the called subscriber by about 2½ minutes per hour.

Moreover, automatic release, in full automatic toll service, results in a saving of 1 minute per hour, or 6 seconds per connection.

In accordance with the traffic curves, it is possible to calculate for 22 toll lines and with a delay of 4%, a line efficiency of 45 minutes. It is interesting to note that observations of actual

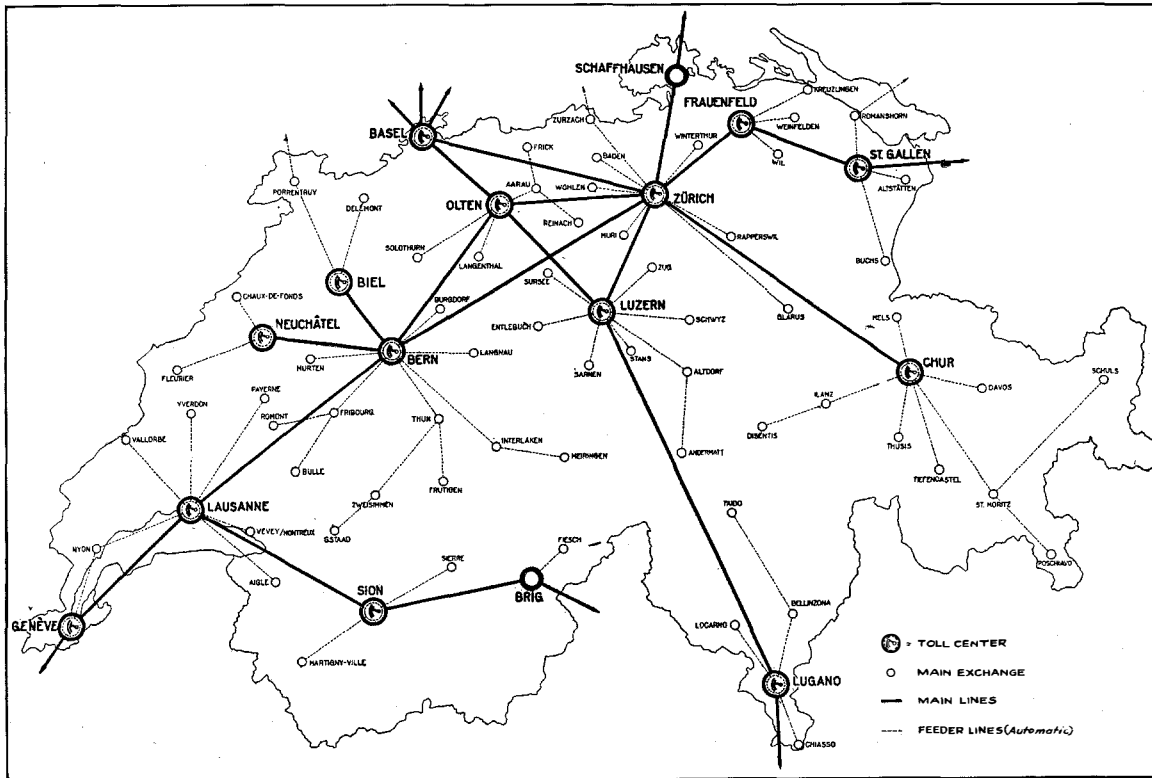

Figure 2—Plan for a Future Swiss Toll Network.

service have shown an efficiency of at least 55 minutes.

The cost of toll lines being very important, advantage must be taken of the possibilities of obtaining, with full automatic toll service, a better revenue on the capital invested in these lines. In the Basle-Zurich traffic, 44 toll lines are used in automatic service. Due to the improved efficiency of 6 charged (paid) minutes per line per hour compared with the manual operating method, there is a total gain of $6 \times 44 = 264$ charged minutes. This gain corresponds to a load of 6 manually operated toll lines, which are thus saved due to automatic operation.

A further advantage of the new operating method results from the automatic message registration (registration of rates). In manual

service the messages are registered by tickets. Such a procedure is not applicable in automatic operation, and registration of the toll rates must be carried out by means used for years in local traffic service. Since, in Switzerland, the rates to be charged for toll connections are always a multiple of the local rates, it has been possible to use the message registers already installed for local service. It was only necessary to provide in the channels required for establishing the toll connections, devices for controlling the zones and the time. These devices mark the toll rates to be charged and operate the local message register of the calling subscriber accordingly, e.g., for charging a toll rate of 70 centimes, seven impulses for stepping the message register 7 times, each step representing 10 centimes (10 centimes being

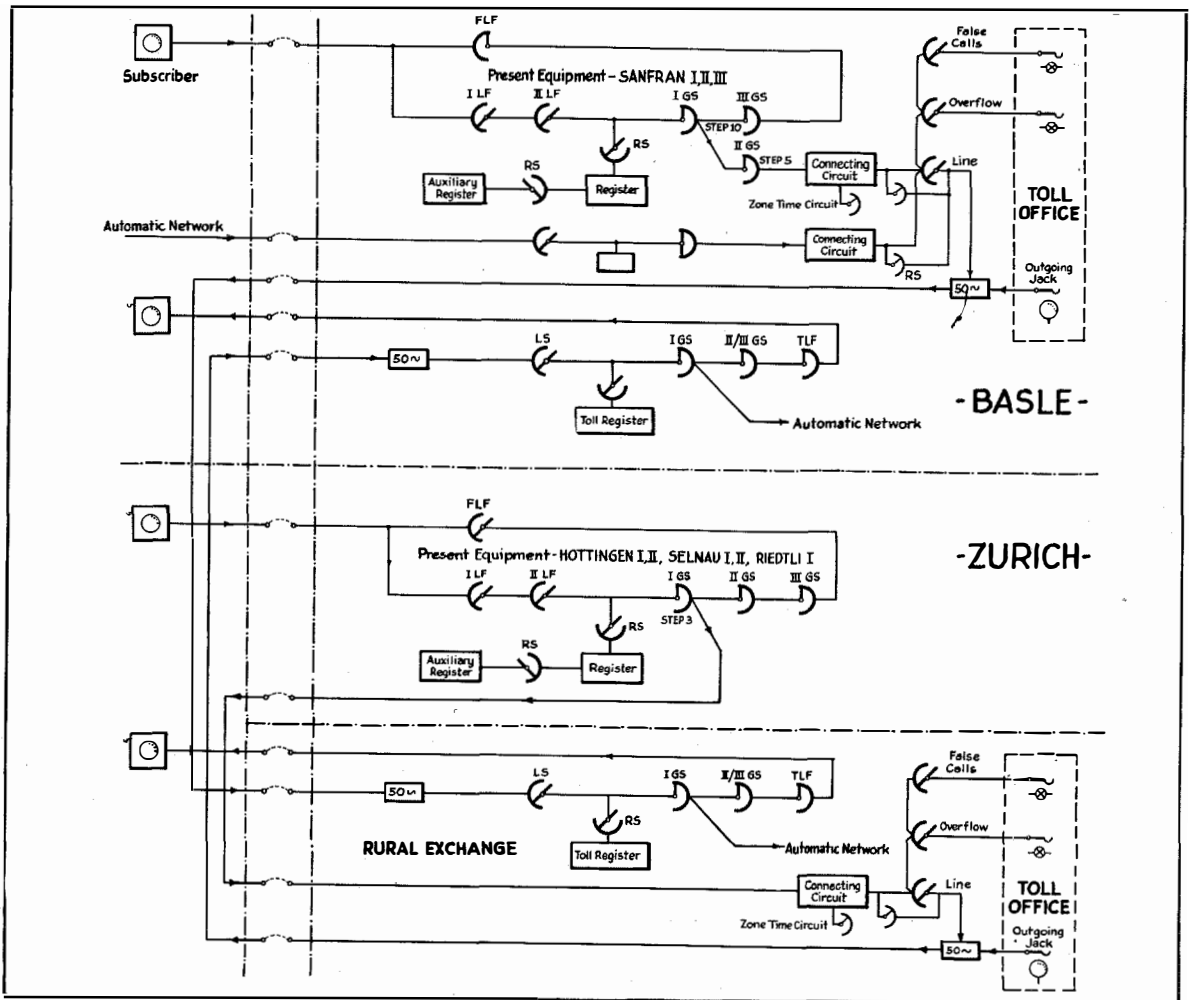

Figure 3—Circuit Diagram for Intercity Service.

charged for a local connection). With the time and zone metering apparatus operating normally, automatic multiple metering as compared to manual methods, offers a greater guarantee against possible charging errors and particularly against wrong time metering. The registration of the toll connections on the local message registers also simplifies the monthly billing. The operation of the automatic time and zone metering will be briefly described hereinafter.

The automatic toll service results, therefore, independent of the advantage due to no-delay service and the consequent increase of traffic, in the following savings:

1. Reduction of operating and accounting expenses.
2. Increase of toll line efficiency.
3. Reduction of errors in charges.

Against these savings, the following expenses are involved:

1. Cost of the required equipment.
2. Cost of maintenance.

B. METHOD OF OPERATION

A few years ago long distance dialing was introduced as a transition stage between manual and the full automatic operation. Long distance dialing was an improvement over the standard manual operation. With the transition equipment, the operator at the place of origin of the call builds up the connection at the distant automatic exchange. In the full automatic toll system, the calling subscriber builds up the desired automatic long distance connection himself.

The automatic toll line equipment binds the automatic city and rural network together much more closely, and the time will come when Switzerland will form one single huge automatic network. Only the extension of the automatic service all over the country will bring a service which will entirely satisfy the subscriber and the Administration, both from an economic and operating standpoint.

The equipments involved in the various exchanges for automatic connection from Basle to Zurich, or vice versa, are indicated in Fig. 3.

As it is not desirable to direct an automatic toll connection entirely from the local register, in view of the many toll features to be considered and the large number of local registers, a small number of auxiliary registers has been provided.

| | | BASLE | | | | ZURICH | | | |
|-------------------|----------------|--------------------|-----|-----------|---------------|-----------|----|-----|----------------|
| Dialling | Local Register | Auxiliary Register | | Operation | Toll Register | | | | |
| | | in | out | | in | out | in | out | |
| Characteristic | 0 | 0 | 0 | — | — | — | — | — | — |
| | | | 5 | | | | | | |
| Subscriber Number | 5 | 5 | 5 | 5 | 5 | Direction | — | — | — |
| | | | | | | Zone | 4 | | |
| Subscriber Number | 4 | 4 | 4 | 4 | 4 | — | 4 | 4 | Step 4 |
| | 7 | 7 | 7 | 7 | 7 | — | 7 | 16 | Terminal 16-30 |
| | 8 | — | — | 8 | 8 | — | 8 | 4 | Step 4 |
| | | | | | | | | 16 | Term. 16-30 |
| | 9 | — | — | 9 | 9 | — | 9 | 2 | Step 2 |
| | 6 | — | — | 6 | 6 | — | 6 | 5 | Term. 5 |

Figure 4—Operation of the Registers Concerned.

Upon receiving the digit "0", chosen for inter-city selection, the local register immediately connects, through a finder, an auxiliary register which registers the impulses dialed by the subscriber.

Fig. 4 shows how the different registers used in establishing a Basle-Zurich connection operate.

The impulse transmission between Basle and Zurich is accomplished with 50 cycle a-c. as in ordinary interurban selection. An outgoing connection from Basle to Zurich is directed by the first digit "0" of the toll prefix over level 10 of the 1st group selector and level 5 of the 2nd group selector for special services, while the second digit "5," designating the Zurich direction, actuates the finders associated with each interurban line of the "Zurich" line group (22 circuits). The digit "5" also marks the zone, in the time and zone metering circuit: 70/40 centimes in the case of Zurich (70 day rate/40 night rate). The other five digits dialed by the subscriber are sent by the auxiliary register as forward-impulses to Zurich into the L.D.D. register (long distance dialing register) which then completes the connection at the Zurich end with the desired subscriber.

It has been mentioned above that the automatic toll lines are also accessible to the toll operators. During the transition stage the toll operators send dialing impulse direct over the toll line to Zurich into the Zurich long distance dialing register, whereas the subscriber in es-

establishing automatic toll connections always dials into the auxiliary register of the exchange where the call is originated. This auxiliary register, therefore, has been made to function also as an impulse corrector, sending correct and regular trains of impulses, and thus making the long distance toll system independent of the subscriber's dial.

Fig. 5 illustrates the principle of operation of the local and auxiliary registers, and the impulse transmission required for the direction and control of apparatus involved in a connection to Zurich. The three local exchanges, Safran I, II and III, in Basle being in the same building, it was possible to use the auxiliary registers of one exchange as reserve (overflow) for another exchange. For a total of $90+80+80=250$ local registers, there are provided only $3 \times 5=15$ auxiliary registers. Ordinarily, the auxiliary registers are installed in their respective exchanges.

Since automatic long distance dialing service excludes all manual operation, the various sequences in building up and releasing a connection are controlled by signals (impulses). Inasmuch as the toll lines are phantomd, 50-cycle signals are transmitted for the direction and control of the apparatus involved. The signal impulses required for building up a Basle-Zurich connection are illustrated in Fig. 6. Accurate and synchronous operation of the apparatus involved

naturally requires that the impulses be accurately transmitted.

The marking of rates and the timing of a connection are automatic, as already mentioned, and are performed by the time and zone metering circuit (Z.T.M.).

The rate marking for toll connections is done differently in the various systems. In case of the S. & H. system, the metering impulses to be charged are transmitted to the message register of the subscriber originating the call at the end of the 3-minute period in the case of rural exchanges, or at the end of a conversation in the case of urban exchanges. In the system of the Bell Telephone Manufacturing Company, and in that of Hasler, the metering is done at the beginning of each 3-minute tax unit.

In accordance with the regulations established by the Swiss Telegraph Administration, the timing should be within the following limits:

| |
|---|
| 180 to 185 seconds in case of a 1-unit connection |
| 360 to 365 seconds in case of a 2-unit connection |
| 540 to 545 seconds in case of a 3-unit connection |
| 720 to 725 seconds in case of a 4-unit connection |

These limits also apply for the timing apparatus used in rapid toll service and in automatic rural systems.

Experience has shown that under certain conditions the metering apparatus remains connected after termination of the conversation in the following cases:

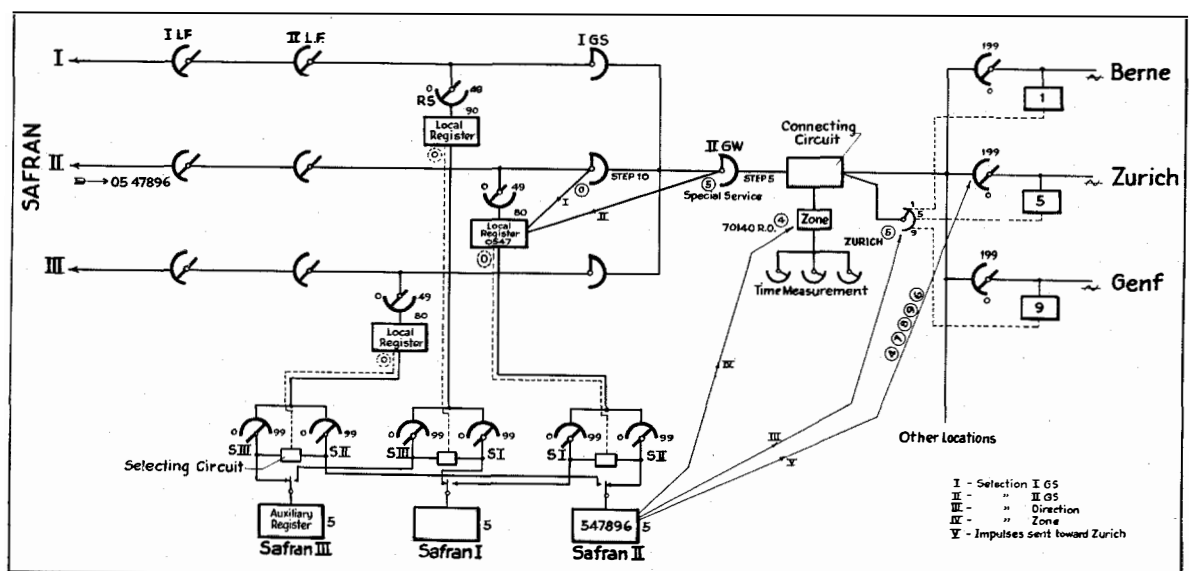

Figure 5—Operating Principle of Local Auxiliary Registers.

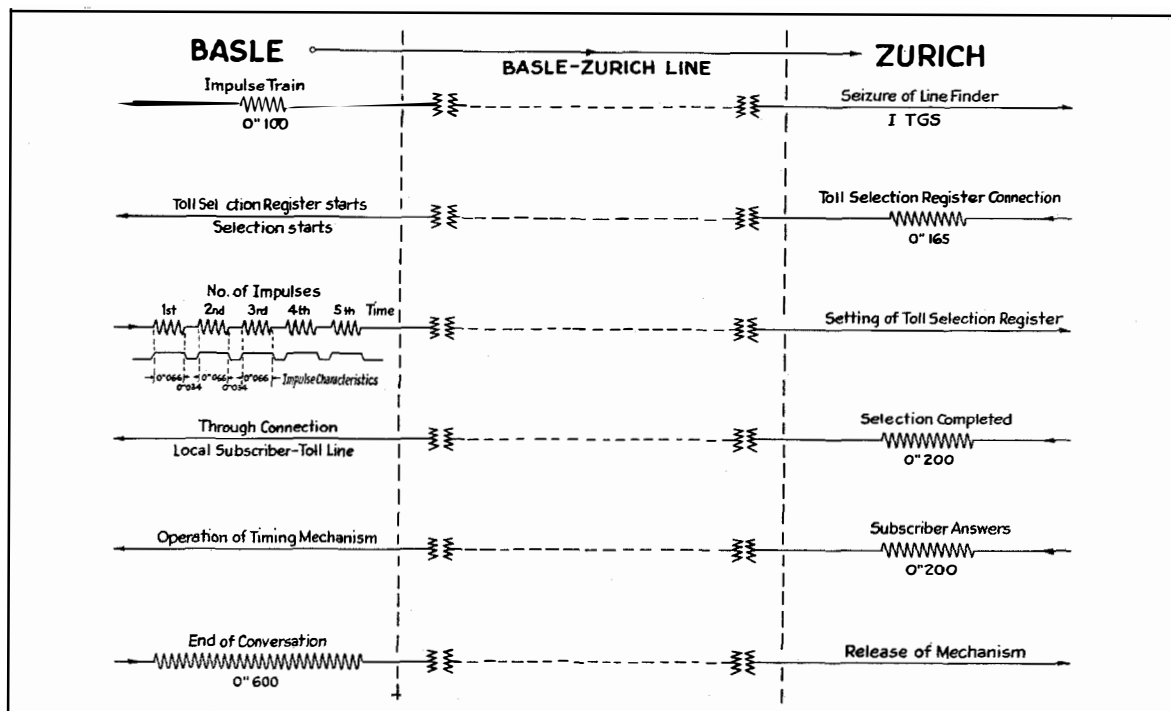

Figure 6—Control Impulses, Basle—Zurich Intercity Connection.

- When the calling subscriber does not restore the receiver at the end of the conversation.
- False operation at the P.B.X. or stations with extension lines (keeping the holding key thrown).
- When the hook switch does not work properly.
- Faults in the central exchange equipment.

In Basle, this happens about twenty times a day with a daily traffic of 100,000 local and toll connections. In order not to inconvenience the subscriber unduly in such cases, means have been provided to break down a connection automatically after 12 minutes. Statistics have shown that only .6 to .8% of toll connections have a duration of more than 12 minutes, so that, of each thousand toll connections, only six to eight are broken down before the subscribers have finished talking.

Circuits have been developed, however, for giving unrestricted timing with a delayed backwards signal after two minutes from the calling subscriber, in case the calling subscriber should not restore his receiver or conditions such as described under (a) to (d) above should obtain. The new circuits also comprise means for switching the 12-minute restriction feature in and out, as required.

The 12-minute restriction feature is provided

also for insertion when it is necessary to prevent the blocking of service by subscribers, intentionally or unintentionally, in certain directions where the number of lines available is limited. In such cases, however, subscribers are informed 30 seconds before the 12 minutes have elapsed, i.e., at 11.30 minutes, by a warning tone, that the connection will be broken automatically.

The principle of operation of the time and zone metering is illustrated in Figs. 5 and 7. As may be seen from these two figures, the rate relays of the time and zone meters are set, for connections towards Zurich (digit 5 of the toll prefix), by the sending of four impulses from the auxiliary register, corresponding to the rates 70 (day) and 40 (night). This setting is done before the connection is completely established.

The answering of the subscriber at Zurich is signalled back to Basle, as indicated in Fig. 6, the signal causing the closing of contact K (Fig. 7) and, in turn, metering as follows:

- The step-by-step switch "2" steps into position 1.
- The interrupter sends impulses (see arrows) to step-by-step switch "3." The impulses are transmitted through the step switch and the rate relays to the message register of the subscriber who originated the call. The rate relays cut off the subscriber's

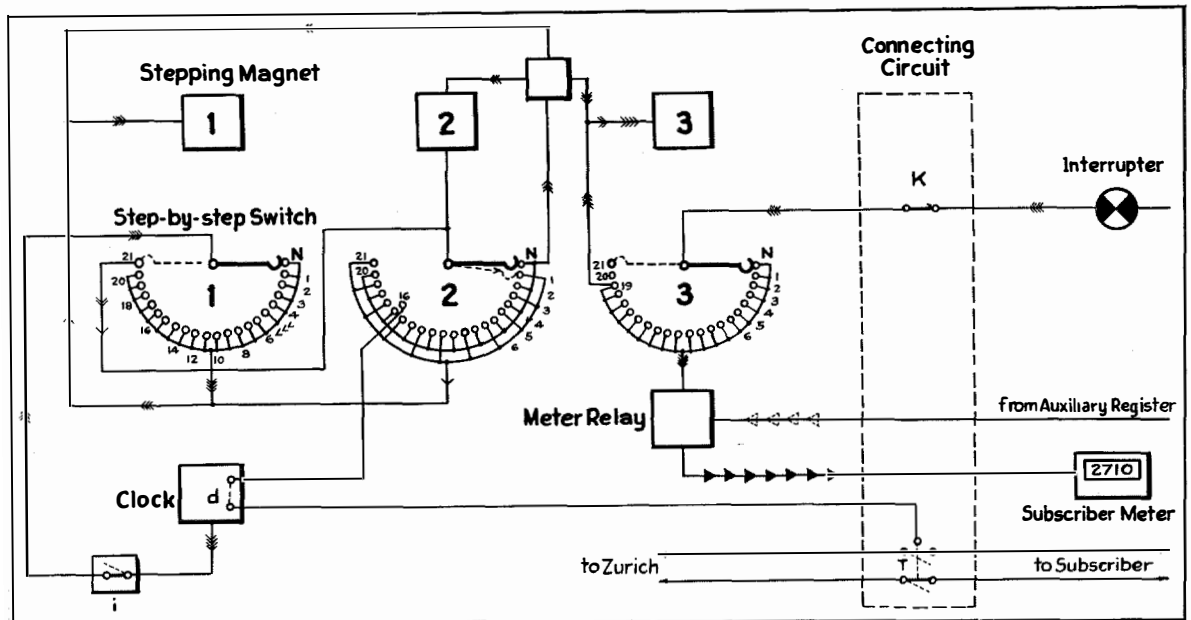

Figure 7—Zone Time Metering—Principle of Operation.

meter after seven impulses, corresponding to the rate of 70 centimes (1 unit), once these impulses have been passed to the subscriber's meter.

- (c) The contact "i" is closed, so that an impulse is sent from the precision master clock every 2 seconds to the step switch "1."

Due to these 2-second impulses the step switch "1" steps forward until the connection is released. The 3-minute charge unit is measured as follows:

1st period. When step switch "1" reaches position 21, the 22nd impulse passes over position 21 (switch "1") to switch "2" and from there, over position 1, to switch "1." Switch "1" moves to N, step switch "2" to position 2. Switch "1," therefore, requires $22 \times 2 = 44$ seconds for again reaching its normal position.

2nd period. In the 2nd period, switch "1" moves in precisely the same way to position 21. The 22nd impulse of this period passes over position 22 to switch "2" and from there, over position 2, to relay V, which suppresses the 22nd impulse. The 23rd impulse, over the same circuit, again reaches relay V, which this time, however, transmits the impulse to all the three step switches, so that switch "1" returns to N, switch "2" to position 3 and switch "3" to position 21. In order to return to its normal position once more, switch "1" this time requires $23 \times 2 = 46$ seconds.

3rd period. The 3rd period develops in the same way as the 1st one. At the end of the period, switch "1" is at N, switch "2" at 4 and switch "3" at 21. The time elapsed is 44 seconds.

4th period. Towards the end of the 4th period, switch "1" is again at position 21. The 22nd impulse of this period reaches position V and is suppressed. As in period 2, only the 23rd impulse sends switch "1" to N; switch "2" is on 5 and switch "3" on N. Thus the interrupter is again connected to switch "3," resulting in the stepping of the switch. For the 2nd time, after the elapse of 180 seconds or 3 minutes, seven impulses are sent over the rate relays to the message register of the subscriber's line, resulting in the metering of the 2nd unit (beginning of the 2nd unit).

Up to the 2nd metering there have elapsed:

| | |
|----------------------|-----|
| 1st period | 44" |
| 2nd | 46" |
| 3rd | 44" |
| 4th | 46" |

4 periods 180" = 1 tax unit

After four further periods the metering of the 3rd unit is effected.

For the automatic breakdown of a connection after 12 minutes, contact "d" is closed. The effect thereof—at the end of the four tax units, i.e., after 12 minutes or $4 \times 4 = 16$ periods (4×180 seconds), with step switch "2" at position 16—is that several relays are operated in the connecting

circuit over an extra brush of step switch "2," causing the automatic breakdown of the connection.

From the above description, it is apparent that the time measurement is absolutely precise. However, in order to give the subscriber the benefit of the full "2 seconds" of the first 2-second impulse at the beginning of a conversation, means are provided for the suppression of this first impulse in the time measurement. In this way, the subscriber always has the benefit of 180 seconds in the 1st unit, in most of the cases even 182 seconds. The change from the day to the night rate, or vice versa, at 19.00 in the evening (7 P.M.) and 8.00 in the morning is also accomplished automatically by the precision clock.

C. FULL AUTOMATIC TOLL SERVICE FROM AND TO THE AUTOMATIC DISTRICT

As may be seen from Fig. 3, the automatic toll plant at Basle is also accessible to the subscribers of the automatic rural district. All rural exchanges are for this purpose provided with means for registering the toll prefix. The rural centre exchanges are equipped, in a manner similar to the Basle city exchange, with a small number of auxiliary registers, which are connected if the 1st digit received in the local register is "0," the 1st digit of the toll prefix. The connection of the auxiliary register to the rural centre exchange local register is effected by relays. The digits following the "0" of the toll prefix are then taken by the auxiliary register, which directs the connection as required.

The traffic incoming from the long distance automatic toll lines for the rural district is directed over the incoming automatic toll switching equipment and routed from the 1st toll group switch to the rural network, as illustrated in Fig. 3.

D. SERVICE OBSERVATIONS

The quality of the automatic toll service can be determined by:

- (a) Observations on toll lines.
- (b) Service observation in the local exchanges.
- (c) Test calls.

Observations (a) are principally for determining the extent of utilisation of the lines; (b) and (c) give a picture of the quality of the service.

The percentage of connections established daily in the Basle-Zurich direction (1500)

amounts on an average to 1.5% of the total local and toll traffic of 100,000 connections.

Since the automatic toll service was introduced, the following observations have been made:

| Months | SAFRAN I | | | | SAFRAN II | | | |
|---------------|---------------------------|-----------|------|--------|---------------------------|-----------|------|--------|
| | No. of Observations Total | To Zurich | | Faults | No. of Observations Total | To Zurich | | Faults |
| | | No. | % | | | No. | % | |
| May | 2431 | 41 | 1.69 | | 1281 | 9 | 0.70 | |
| June | 2068 | 41 | 1.98 | | 1271 | 16 | 1.26 | |
| July | 1910 | 10 | 0.52 | | 1067 | 9 | 0.85 | |
| August . . . | 2109 | 38 | 1.80 | | 1258 | 10 | 0.79 | |
| Sept. | 1395 | 29 | 2.08 | | 733 | 8 | 1.09 | |
| Total . . . | 9913 | 159 | 1.6 | | 5610 | 52 | 0.95 | |

Test calls are necessary in order to obtain a correct idea of the quality of the service, since the number of automatic toll connections which can be made the object of regular service observations is inadequate. The results of test calls during the past few months are as follows:

| Month | Total Test Calls | Number Bad | % |
|---------------------|------------------|------------|------|
| July | 370 | .. | .. |
| August | 2850 | 12 | 0.42 |
| September | 2695 | 9 | 0.33 |
| Total | 5915 | 21 | 0.35 |

E. MISCELLANEOUS

Plans are already under way for the introduction of automatic toll service from Basle to cities equipped with telephone exchanges of other systems, supplied by S. & H. and Hasler.

To conclude this part of the description, it can be stated with satisfaction by the Telephone Administration that the introduction of automatic toll service has been favourably received by the subscribers and is regarded by them as a great improvement.

II. Rapid Toll Service

A. GENERAL

About six years ago rapid toll service was introduced (No. 13), i.e., no-delay service to neighbouring localities within the 20 and 30 centime zones. The equipment, intended only for the transition stage, was very simple. The service

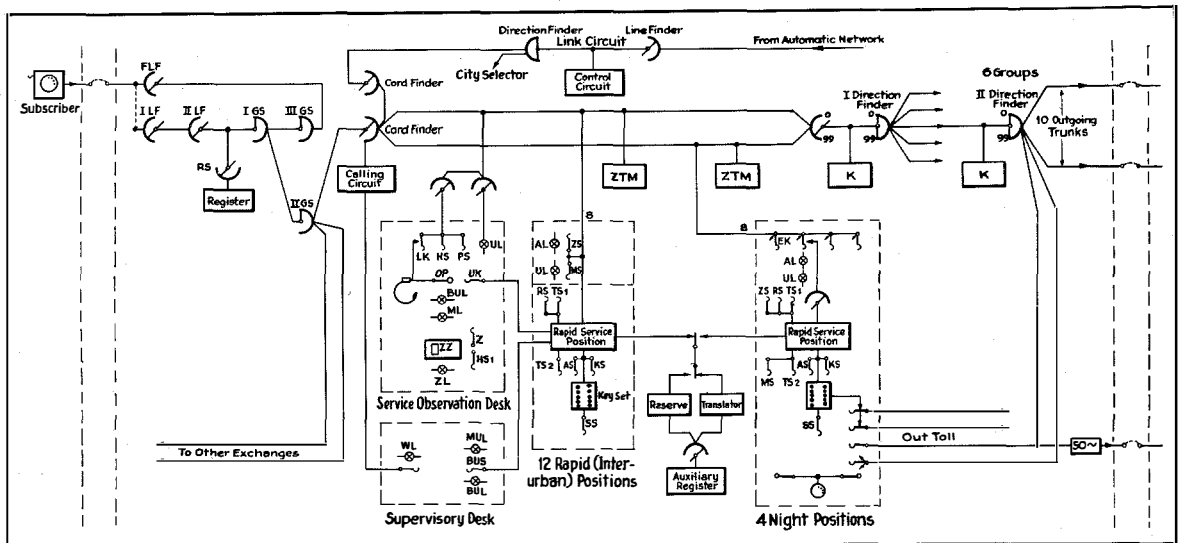

Figure 8—Circuit Diagram, Rapid Service at Basle.

was given on ordinary "A" toll positions. Answering and establishing connections towards the subscriber at the distant end were done with answering and calling plugs of ordinary toll cord circuits. For the timing of the connections, existing devices were used. The most important new feature of that service was the multiple metering which required the toll operator to send a series of impulses towards the message register of the subscriber who originated the call, the number of impulses corresponding to the toll rate to be charged. It was, therefore, possible to eliminate the time ticket as well as the rate billing (clerical) work.

Multiple metering had already been considered at the time the first automatic local equipments were installed in Basle, and special arrangements were made for the later introduction of such a service.

As mentioned previously, automatization of the entire toll plant can only be carried out in steps. However, in order to improve the quality of the toll service as rapidly as possible, arrangements were necessary for the extension of the rapid toll service over greater distances, from 20 to 50 kms., from 50 to 100 kms., and over 100 kms. This was made possible by appropriate modification of the exchange equipment.

There exist today divergent views concerning the best operating methods for providing rapid toll service; hence, various different types of

equipments have been built for accomplishing the same purpose. Most of these equipments are based on the call distribution scheme with plug-ended cords. With such a scheme the operator must plug the particular monocord into the multiple jack of the desired toll line; she must ask for the number of the subscriber desired, obtaining the connection by dialing in case the distant exchange can be reached automatically; she must mark the rate of the zone for correct metering; she must start metering at the beginning of the conversation; and, finally, she must break down the connection by withdrawing the plug from the multiple jack. The time interval is generally measured with automatic time meters. In such systems, the following disadvantages have been taken over from the old manual practice:

- (a) It is necessary to test the line, whether free or busy, or it is necessary to provide all toll lines with multiple busy lamps. There is the danger of double connections.
- (b) The possibility exists that the operator may depress the wrong rate key for marking the zone (metering error).
- (c) The toll lines and in certain cases the subscribers' lines are kept busy unduly long, i.e., until the connection is broken down by the operator. This reduces the efficiency of the toll lines.

Whilst it is not possible to determine exactly by calculation the disadvantages of (a); those of (b) and (c) influence the revenue derived from

the toll lines, thus making it necessary to consider this financial factor when designing new equipments.

Regarding (b): statistics show that in manual rating, errors to the disadvantage of the subscribers and to the Telephone Administration occur in the proportion of 1:2.

Regarding (c): on the basis of line observations cited under section 1-A, it has been established that the breakdown of a manual connection requires 6 seconds, which means that the toll line is kept uselessly busy for 6 seconds. With an average load of 60 connections per rapid toll operator per hour, this results in a loss of $60 \times 6 = 360$ seconds or 6 minutes per hour, a loss which is, of course, distributed over different lines and which reduces the revenue on the capital invested in the toll lines and toll exchange equipment. This loss applies, of course, only to the busy hours. In Basle, where during these hours twelve rapid toll operators are employed, it has been possible to recover $6 \times 12 = 72$ minutes per hour, by the introduction of automatic release of connections.

B. METHOD OF OPERATION

With the extension of the rapid toll service to the 50 and 70 centime zones, it was necessary to install in the Basle toll exchange a new rapid toll exchange equipment. It was possible also, on that occasion, to consider eliminating all the known disadvantages in the design of the new equipment by adapting, so far as possible, the principles of automatic service. This step was the more justified as it was possible to use a large part of the old Birsig call distribution equipment for the rapid toll board. The new rapid toll board, designed and supplied by the Bell Telephone Manufacturing Company, is illustrated diagrammatically in Fig. 8.

As may be seen from this diagram, a rapid toll connection is established on a cordless basis. The operator does not test the lines, neither does she determine the rate zone nor break down the connection at the end of the conversation. All these operations are performed automatically. For establishing a connection in a certain direction, the rapid toll operator marks on a keyset a 2-digit rapid toll prefix:

For Berne.....No. 53
 For Lucerne.....No. 67
 For Aarau.....No. 22
 For Lenzburg.....No. 36
 For Thun.....No. 78, etc.

When pressing down the prefix, the rate to be charged is also marked automatically on the time and zone metering apparatus.

In the case of a connection established in tandem through an exchange connected to the toll board, however, it may be necessary to charge a rate different from that to the tandem exchange; two different prefixes, therefore, are provided for tandem connections and for terminating traffic, respectively. With both prefixes, the same direction and group of lines are selected, but the rate charged is that of the end destination.

For Langenthal, for example, the prefix is 32 and the rate charged is 50 centimes. Huttwil is obtained by tandem connection through Langenthal, in which case the prefix is 33 and the rate charged is 70 centimes.

Points which can be reached over manual lines, as well as over lines with long distance dialing, also have two prefixes. One prefix is used for the selection of manual lines and the other, for the selection of long distance dialing lines.

If it is desired to reroute a connection in the event that the group of toll lines in the wanted direction is busy, the operator may do so and may obtain the connection via another city without resetting of the toll rate already marked in the time and zone metering apparatus. Means are provided in such cases to maintain the rates marked in the time and zone metering apparatus.

The traffic paths involved in a rapid toll connection are illustrated in Fig. 9.

When plugging the operator's telephone set into a position, the switching circuits of that particular position are cut into service. Calls from the city exchange for rapid toll connections are distributed automatically over the various rapid toll positions. Each position receives and replies only to one call after another. In case there are more calls incoming than there are free positions, the overflow calls are parked in sequence in a waiting circuit and are released in the proper order as soon as positions become free, so that the call which comes in first is answered first, etc. Each position is equipped with a translator to take care of the proper direction of the connections. For replacing a defective translator, there are provided three reserve translators which can be switched in by the supervisor.

A call coming in on a rapid toll position, lights the white calling-lamp AL (Fig. 8). At the same time a short tone signal is given to the operator who answers by saying "Schnelldienst" (Rapid

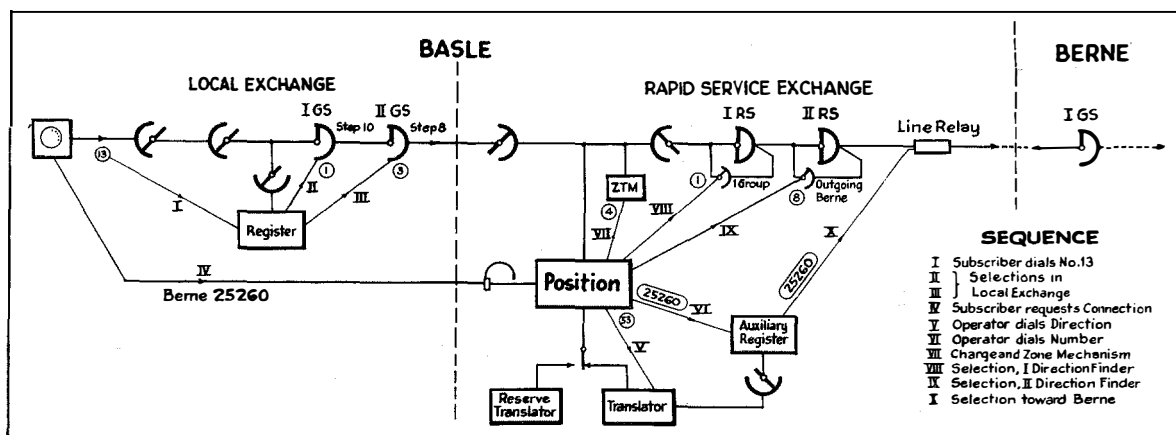

Figure 9—Traffic Paths Involved in a Rapid Toll Connection.

Toll Service). Connection of an auxiliary register to the translator occurs immediately, and is indicated to the operator by the lighting of the supervisory lamp UL.

The prefix of the desired direction is transmitted to the translator by pressing down the corresponding number on the positional keyset. The auxiliary register connected to the translator receives, in the case of a connection to an automatic area, the number of the wanted distant subscriber. In the case of a connection to a manual exchange, the auxiliary register will not be used and is released immediately after marking of the direction in the translator.

In order not to complicate the circuit for taking care of 2, 4, 5 and 6 digit numbers (Berne, Olten, Biel, Lucerne and Zurich), a sending start key SS is operated after the last digit has been pressed down on the keyset. The sequence of the switching stages for building up a connection may be seen from Fig. 9. During the progress of the connection, the supervisory lamp UL is extinguished, and the local subscriber is disconnected automatically from the operator. After completion of the connection, the supervisory lamp UL lights up again; the operator throws the monitoring key MS (1st movement) and by doing so connects the local subscriber to the toll line. When the called subscriber replies, the operator throws the metering start key ZS (2nd movement), whereupon time and zone metering starts; lamp UL is extinguished. For a normal connection the operator, therefore, has to make only two movements (throwing of keys).

The operator may supervise a connection at any moment by throwing the monitoring key MS, one of which is provided in each connecting circuit. In case of irregularities, she also can talk and split the connection by throwing the positional splitting keys TS-1 and TS-2, and she can ring with the positional key RS.

The system and equipment have been designed intentionally in a manner such that the operator remains connected during the entire progress of the connection until conversation starts. With this arrangement the principle generally recommended by business people, "service to the customer," is fully realised. In case difficulties are encountered in building up a connection (if the desired exchange or the desired subscriber does not answer, wrong connection, etc.) the operator always remains in contact with the calling subscriber and cannot leave him unattended, as is often done when service is given simultaneously to several subscribers. Since the operator is bound to obtain a certain minimum number of connections per hour, she does everything possible to establish the desired connection within minimum time and to see that the distant exchange as well as the distant subscriber reply promptly to the call, thus promoting increased efficiency in the use of the toll lines. During the time the splitting key TS-1 or TS-2 is thrown, time metering is stopped. With the number keyset is further associated a push-button key, KS, for correcting an error in the prefix or subscriber number, as well as a push-button, AS, for rejecting false calls.

The method of operation of the time and zone metering apparatus is similar to that of the automatic toll line equipment. The translator sets the time and zone metering apparatus as follows:

| | | |
|---------------|-----------------|----------------------------|
| 1st Rate Zone | 20 Centimes | Translator Sets 1 Impulse |
| 2nd Rate Zone | 30 Centimes | Translator Sets 2 Impulses |
| 3rd Rate Zone | 50/30 Centimes | Translator Sets 3 Impulses |
| 4th Rate Zone | 70/40 Centimes | Translator Sets 4 Impulses |
| 5th Rate Zone | 100/60 Centimes | Translator Sets 5 Impulses |

To enable the operator to exercise visual control over the zone metering, arrangements have been made for flashing the supervisory lamp UL whenever metering impulses are sent to the message register of the subscriber. The supervisory lamp flashes in sequence with the impulses sent to the message register, e.g., for a rate of 70 centimes, seven times.

When the calling subscriber restores his receiver at the end of the conversation, the supervisory lamp UL is extinguished and all apparatus involved in the connection, including the toll lines, is released and becomes free for the next call. In the case of a manual line connection, when the connection is released, a clearing signal (a short ring) is sent automatically to the distant exchange. The rapid toll equipment contains the necessary features for breaking down a connection after 12 minutes; however, since the connections remain under the control of the rapid toll operator, the features of automatic breakdown after 12 minutes are normally not required and are used only in case of heavy traffic. Supervisory lamps at the monitoring desk permit the toll chief operator to supervise the occupation of the rapid toll positions, the connection of reserve translators, the unnecessary listening in on toll connections, and the reply to waiting subscribers.

With the automatization of several operations, it was possible to simplify considerably the positional equipment. Also, the expensive toll multiple and the entire jack field were eliminated. The connecting circuits (eight) appear in the positions simply in two lamps, AL and UL, and the double key ZS/MS, and the positional equipments comprise a double key TS-1—TS-2, a ringing key, RS, a number-keyset with ten push-buttons, and three additional key-buttons, AS, KS and SS. In addition to this equipment, there still exists one service line per position.

For the night service there are provided eight common connecting circuits on four night positions, which are operated in the same way as the corresponding circuits at the day-positions (see Fig. 8).

C. RAPID TOLL LINES FOR THE RURAL DISTRICT

From the junction diagram, Fig. 8, it may be seen that the subscribers of the rural district have the same facilities for obtaining rapid toll connections as are offered to the Basle City subscribers.

Notwithstanding the fact that the rural subscribers are situated at a considerable distance from the Basle rapid toll board, such connections are also metered on the subscriber's message register, and the rate setting is controlled from the Basle rapid toll board by zone and time metering as described below.

The impulses from the translator to the time and zone metering apparatus in rapid toll connections from Basle City are also transmitted to the corresponding apparatus at a calling rural exchange for setting the time and zone metering

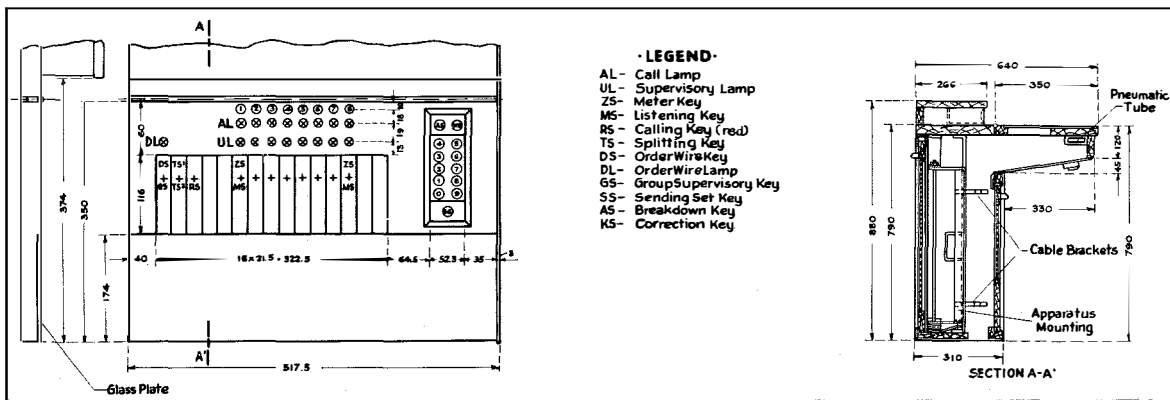

Figure 10—Interurban Position for Rapid Service.

circuit which sends the necessary impulses for operating the subscriber's message register in accordance with the rates to be paid.

Metering starts in the way already described when the R.T. operator throws the metering start key "ZS," whereby a short impulse is sent backwards to the rural exchange, corresponding to the signal "answer of the called subscriber" in automatic district connections.

In case an R.T. operator corrects a connection by pressing the key "KS," the time and zone metering apparatus at the rural exchange must be returned to normal and set again to correspond to the new connection. For this purpose, a long impulse is sent to the rural exchange, whereupon the time and zone apparatus returns to normal and is again ready for the new setting.

Likewise, in case of rapid toll connections from rural, the timing is stopped while the splitting key TS-1 or TS-2 is thrown. This is possible, as the time measuring is done at Basle. The rapid toll board sends an impulse to the rural exchange at the beginning of each 3-minute unit, whereupon a further rate-unit is charged on the message register of the calling rural subscriber.

The rapid toll calls from rural subscribers are released automatically, as already described.

D. SERVICE OBSERVATIONS

5500 calls, or 85%, of the daily rapid toll traffic are routed to 20, 30, 50 and 70 centime zones. Of this traffic, 85% is established over manual lines and 15% over long distance dialing toll lines.

With a load of 60 to 65 connections per operator, the average answering time of a call is 6 seconds; 75% of these calls are answered in less, and 25% in more, than this average of 6 seconds.

For establishing a connection an operator requires:

When calling a *manual line*:

| | |
|---|------------|
| Conversation with the calling subscriber..... | 5 Seconds |
| Service connection with the distant exchange..... | 13 Seconds |
| Waiting time until the called subscriber answers..... | 25 Seconds |
| Total..... | 43 Seconds |

When calling a *long distance dialing line*:

| | |
|--|------------|
| Conversation with the calling subscriber, sending the number on the keyset and selection of the called subscriber..... | 13 Seconds |
| Waiting time until the called subscriber answers (automatic ringing)..... | 20 Seconds |
| Total..... | 33 Seconds |

The time required for establishing a connection over long distance dialing lines is thus 10 seconds shorter. If all toll lines were arranged for long distance dialing, the load per operator would increase by nearly 25%; in other words, it would be possible to spare one operator per group of four or five. The efficiency of the new equipment will increase with automatization, whereby manual toll lines are converted gradually to long distance dialing.

Although rapid toll service, as described above, only represents a transition stage between the old manual toll practice and full automatic toll service between subscribers, it can be stated even now that this method of handling rapid toll traffic offers marked advantages to the subscribers and to the Telephone Administration, both from a service and an economic viewpoint. Since the rapid toll equipment is merely transitional, the circuits and equipments have been developed so that they can be used later on for the automatic toll service which will be introduced gradually. This would not be practicable with rapid toll boards using plugs and jacks. The operators appreciate the advantages of the automatization introduced in the rapid toll service.

III. Conclusions

Fig. 11 shows the cities and districts reached in accordance with the first schedule from Basle and its rural district, namely:

- (a) Over full automatic lines—Zurich.
- (b) Over rapid toll long distance dialing lines—Berne, Biel, Olten and Lucerne.
- (c) Over manual rapid toll lines or in transit over lines under (a) and (b)—all the remaining cities within 100 kms. radius from Basle.

Rapid toll connections beyond the 100 kms. radius are scheduled for introduction in 1934.

The extension of the rapid toll service to ad-

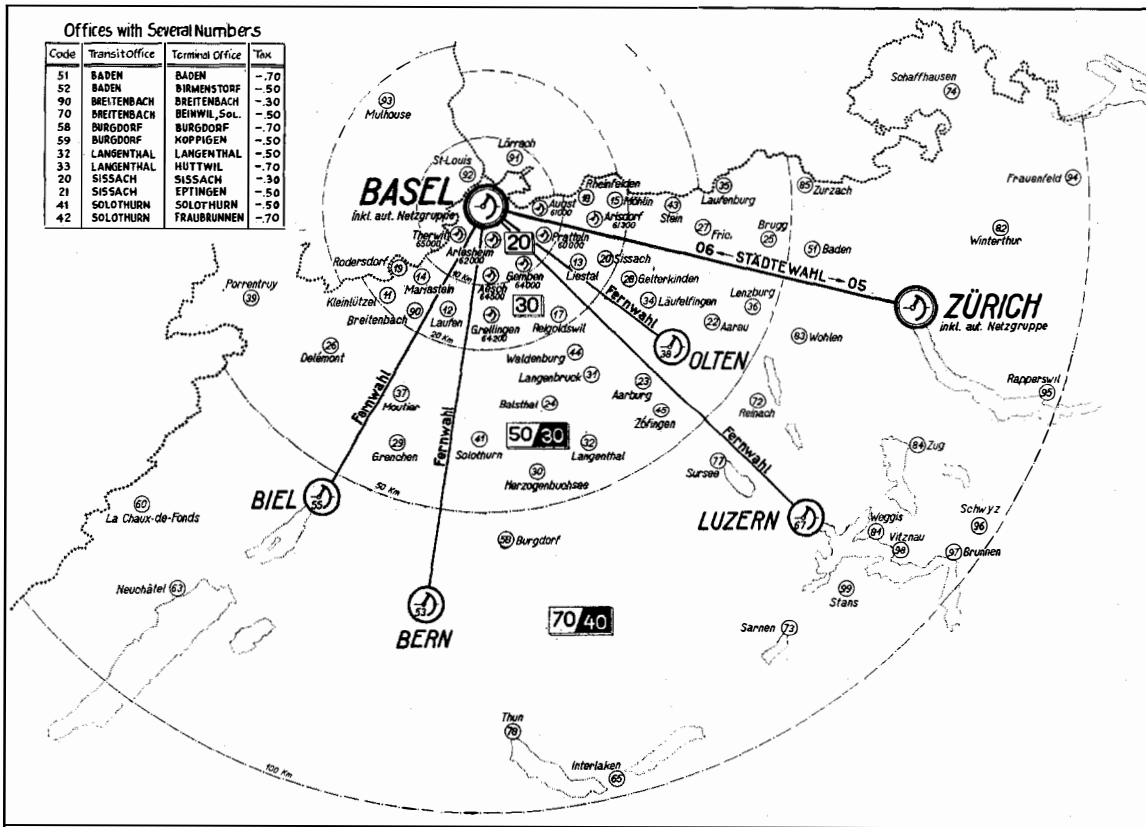

Figure 11—Zones from Basle Served Automatically and by Rapid Service.

adjacent zones in Germany and France is foreseen for 1934. With the opening of the R.T. service to these zones the corresponding rates, at present 25 and 35 centimes (night rates Germany) and 75/45 centimes (2nd zone France), will be reduced to 20 and 30 centimes and 70/40 centimes, respectively.

More than 70% of the complete Basle toll traffic is now handled in accordance with the two new operating methods: either full automatic, or via the rapid toll board with the corresponding elimination of time tickets. This results in a considerable reduction of the clerical and billing work (reduction of about three clerks).

As an argument against the introduction of direct automatic multiple and zone metering on the subscriber's message register, the remark is very often made, that such service renders rate quoting to subscribers impossible.

Subscribers who wish to be informed in regard to the rates charged on the subscribers' meters

have, as heretofore, the possibility of ordering the connection via the old standard channels by dialing No. 14 for the recording board where the connection is ticketed. Investigations have, however, shown that the old facilities are now rather seldom used. The following table gives information on this point:

Rate quoting requested in connection with rapid toll service:

| Zone | Number of Connections | With Request for Rate Quoting | % |
|--|-----------------------|-------------------------------|------|
| 20/30..... | 2000 | 25 | 1.25 |
| 50..... | 1500 | 60 | 4. |
| 70..... | 2000 | 100 | 5. |
| Automatic toll service to Zurich 70 centimes.... | 1500 | 60 | 4. |
| Total..... | 7000 | 245 | 3.5% |

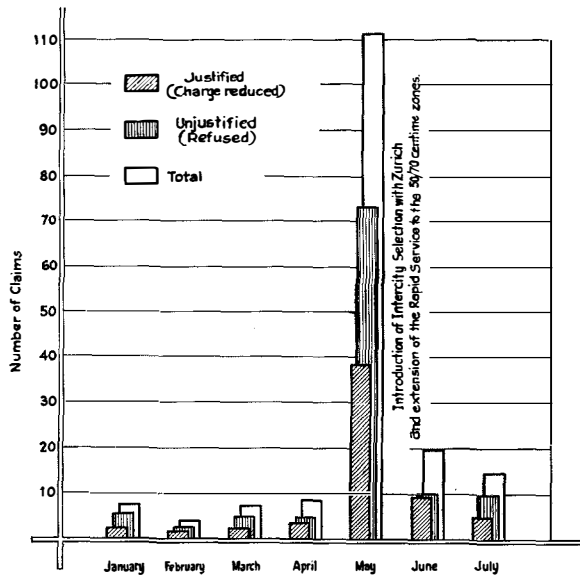

Figure 12—Claims Concerning the Functioning of the Meters in 1933, About 18,000 Subscribers.

The number of cases where rate quoting was requested after the release of the automatic or rapid toll connections and where naturally no information could be given, was not quite 1%.

In public telephone stations, hotels, restaurants, etc., rate quoting apparatus, so-called tax indicators, are usually installed.

Fig. 12 gives a picture of the claims received by the Administration's billing section concerning the monthly bills, based on the reading of the subscriber's message register; it shows the number of claims before and after the introduc-

tion of the automatic zone—and multiple metering. It will be seen that the subscriber very soon got used to the automatic metering. With a total automatic registration of messages on subscribers' meters in the amount of Swiss Francs 300.000.- per month, claims which are justified reach in total the average amount of Swiss Francs 500.- to 600.- or 0.2% per month.

From this point of view also, nothing opposes the extension of the use of automatic zone- and time-metering.

In conclusion, it should be stated that the claims received by the Toll Chief Operator due to false connections or bad transmission, justifying a reduction in rates, viz., time charged, are very few in number (Fig. 12):

| | Number of Connections | Claims Justified | % |
|----------------------------------|-----------------------|------------------|------|
| Rapid Toll Service | 5500 | 30 | 0.45 |
| Automatic Toll Service | 1500 | 5 | 0.34 |

In the interest of both telephone subscribers and the Telephone Administrations, it is hoped that the preceding considerations, which give briefly information concerning ways and means employed thus far for handling toll traffic automatically, will help to clear and solve toll problems still pending and will assist in the further development of long distance telephone systems and equipment of still greater efficiency.



The telephone in the home

No item of equipment contributes more to the security, happiness and efficiency of the home than the telephone.

THERE ARE TIMES when it is virtually urgent—a sound in the night, a whiff of smoke, a sudden illness.

THERE ARE TIMES when it brings happiness unexpectedly to an otherwise dull moment—a friend calls to chat, a son out of town calls up to say “hello,” a neighbor calls to give an invitation to a weekend party.

THERE ARE TIMES when it saves time and gets things done more quickly and efficiently—a hurry-up call to the grocer for an item forgotten, a whole day’s shopping done in the span of a few minutes, a round of calls at the last minute to get someone to take the place of an invited guest who has sent regrets.

Every minute of the day or night the telephone in the home stands ever-ready to serve—to carry your voice to millions of other telephones throughout the world—to bring to you the voices of those who wish to get in touch with you—a vital item of equipment in the home.

INTERNATIONAL TELEPHONE AND TELEGRAPH CORPORATION

BOARD OF DIRECTORS

| | |
|--|--|
| <p>ARTHUR M. ANDERSON J. P. Morgan & Co.</p> <p>SOSTHENES BEHN, President</p> <p>F. WILDER BELLAMY Dominick & Dominick</p> <p>EDWARD J. BERWIND Chairman, Berwind-White Coal Mining Company</p> <p>EDWIN F. CHINLUND, Vice-President and Comptroller</p> <p>PHILIP K. CONDUCT Executive Vice-President, International Standard Electric Corporation</p> <p>JOHN W. CUTLER Edward B. Smith & Co.</p> <p>R. FULTON CUTTING Financier</p> <p>CHARLES E. DUNLAP President, Berwind-White Coal Mining Company</p> <p>GEORGE H. GARDINER Davis Polk Wardwell Gardiner & Reed</p> <p>GEORGE S. GIBBS President, Postal Telegraph and Cable Corporation</p> <p>A. H. GRISWOLD Executive Vice-President, Postal Telegraph and Cable Corporation</p> | <p>ALLEN G. HOYT Vice-President, The National City Bank of New York</p> <p>RUSSELL C. LEFFINGWELL J. P. Morgan & Co.</p> <p>CLARENCE H. MACKAY Chairman of the Board, Postal Telegraph and Cable Corporation</p> <p>JOHN L. MERRILL President, All America Cables, Incorporated</p> <p>WALTER E. OGLIVIE President, Havana Terminal Railroad Company</p> <p>HENRY B. ORDE President, Shanghai Telephone Company</p> <p>BRADLEY W. PALMER Palmer, Dodge, Barstow, Wilkins & Davis Boston</p> <p>GEORGE E. PINGREE President, International Standard Electric Corporation</p> <p>WOLCOTT H. PITKIN, Vice-President and General Attorney</p> <p>LEWIS J. PROCTOR, Vice-President</p> <p>LANSING P. REED Davis Polk Wardwell Gardiner & Reed</p> |
|--|--|

GEORGE H. GARDINER
General Counsel

OFFICERS

| | | |
|--|--|--|
| <p><i>President</i> SOSTHENES BEHN</p> <p><i>Vice-Presidents</i> LEWIS J. PROCTOR GEORGE E. PINGREE PHILIP K. CONDUCT JAMES E. FULLAM</p> <p><i>Vice-President and General Attorney</i> WOLCOTT H. PITKIN</p> <p><i>Secretary</i> SAMUEL G. ORDWAY</p> | <p><i>Vice-Presidents</i> JOHN L. MERRILL FRANK W. PHELAN WILLIAM F. REPP A. H. GRISWOLD</p> <p><i>Vice-President and General Technical Director</i> GERALD DEAKIN</p> | <p>FRANK C. PAGE LOGAN N. ROCK GEORGE S. GIBBS</p> <p><i>Vice-President and Comptroller</i> EDWIN F. CHINLUND</p> <p><i>Treasurer</i> JOSEPH A. REDEGELD</p> |
|--|--|--|

THE International Telephone and Telegraph Corporation was organized to cooperate and assist technically and financially in the general development of electrical communications in a broad international sense, and, with respect to the organization and development of national communications systems, it is the purpose of the International Telephone and Telegraph Corporation to develop truly national systems operated by the nationals of each country in which the International Corporation is or may become interested. The International Corporation was not organized with the desire of imposing American practices in its foreign activities. There appeared

to be a fruitful field of service to be rendered in bringing together under one general organization electrical communications systems, and the extension, by the International Corporation to the associated companies, of the technical and financial facilities and direction that might be needed for their intensive and efficient development. The best American practices have been suggested but never imposed. On the contrary, the International Corporation has always been ready and quick to adjust American practices to local conditions and to adopt such local practices as were conducive to the successful development of the various entities.

Licensee Companies

- BELL TELEPHONE MANUFACTURING COMPANY.....*Antwerp, Belgium*
Branches: Brussels.
- BELL TELEPHONE MANUFACTURING COMPANY.....*Berne, Switzerland*
BELL TELEPHONE MANUFACTURING COMPANY.....*The Hague, Holland*
- CHINA ELECTRIC COMPANY, LIMITED.....*Shanghai, China*
Branches: Canton, Hankow, Harbin, Hongkong, Peiping, Tientsin.
- COMPAÑÍA STANDARD ELECTRIC ARGENTINA.....*Buenos Aires, Argentina*
- INTERNATIONAL STANDARD ELECTRIC CORPORATION, *Branch Office,*
Rio de Janeiro, Brazil
- LE MATÉRIEL TÉLÉPHONIQUE.....*Paris, France*
Branch: Rabat, Morocco
- NIPPON DENKI KABUSHIKI KAISHA.....*Tokyo, Japan*
Branches: Osaka, Dairen, Taihoku.
- FERDINAND SCHUCHHARDT, BERLINER FERNSPRECH-UND TELEGRAPHENWERK
AKTIENGESELLSCHAFT.....*Berlin, Germany*
- STANDARD ELECTRIC AKTIESELSKAB.....*Copenhagen, Denmark*
- STANDARD TELEFON—OG KABELFABRIK A/S.....*Oslo, Norway*
- STANDARD ELECTRIC COMPANY W POLSCE SP. Z. O. O.....*Warsaw, Poland*
- STANDARD ELECTRIC DOMS A SPOLECNOST.....*Prague, Czechoslovakia*
Branch: Bratislava.
- STANDARD ELECTRICA ROMANA S/A.....*Bucharest, Rumania*
- STANDARD ELÉCTRICA, S. A.....*Madrid, Spain*
Branches: Barcelona, Santander.
- STANDARD ELECTRICA, S. A.....*Lisbon, Portugal*
- STANDARD ELETTRICA ITALIANA.....*Milan, Italy*
Branch: Rome.
- STANDARD TELEPHONES AND CABLES, LIMITED.....*London, England*
*Branches: Birmingham, Glasgow, Leeds, Manchester, Dublin, Cairo, Johannes-
burg, Calcutta, Singapore.*
- STANDARD TELEPHONES AND CABLES (AUSTRALASIA), LIMITED.....*Sydney, Australia*
Branches: Melbourne: Wellington, New Zealand.
- STANDARD VILAMOSSÁGI RÉSZVÉNY TÁRSASÁG.....*Budapest, Hungary*
- SUMITOMO ELECTRIC WIRE & CABLE WORKS, LIMITED.....*Osaka, Japan*
- VEREINIGTE TELEPHON-UND TELEGRAPHENFABRIKS AKTIEN-GESELLSCHAFT,
CZEIJA, NISSL & CO.....*Vienna, Austria*

Sales Offices and Agencies Throughout the World
